



**VANGUARD**



**2024**  
**PHOTO VIDEO**

# ABOUT VANGUARD

Vanguard is a global company that designs and manufactures tripods, bags, sporting optics, and accessories. For over 30 years, our drive to disrupt mediocrity and our commitment to innovation has allowed us to create the highest-quality products for photographers and outdoor enthusiasts at affordable prices.

Growing into a global leader since its founding in 1986, VANGUARD provides more than our competitors because we are the factory. There are no third-party factories, development or design firms, or other outsourcing of any kind in the process.

Every step is orchestrated by Vanguard's in-house R & D, production, administration, marketing, and sales teams in Vanguard-owned and controlled facilities. This enables us to ensure standout product quality, listen to customers directly, support the professionals, and provide excellent after-sales service. Vanguard is truly a global brand with distribution, sales, marketing, and administrative branches in the U.S., Luxembourg, Spain, Germany, United Kingdom, Japan, and China. From these locations, Vanguard team members collaborate closely to ensure a consistent, efficient global operation.

Every day, hundreds of thousands of photographers and outdoor enthusiasts rely on Vanguard tripods, monopods, ball heads, bags, cases, optics, and more.

Detailed information about our products can be found on our website at [www.vanguardworld.com](http://www.vanguardworld.com)





# TOTAL PRODUCT OWNERSHIP FROM IDEA TO FINISHED PRODUCT

## UNMATCHED QUALITY CONTROL

Vanguard founders credit our success to the people across the globe who have given supportive and valuable feedback about product features and price points over our three decades.





This focus on listening to the market's needs and wants has inspired us to create products with first-of-its-kind features, notable reliability, and impressive price points. Notable industry publications and media have consistently recognized our products' quality and performance. We're privileged to have earned top honors from the Technical Image Press Association, the Red Dot Design Award, iF Design Award, the Industrial Designers Association of America, Gmark, and other respected global associations.



# KEY FEATURES



## PREMIUM HOYA ED GLASS

Setting new standards with a rating of more than 95% light transmission, HOYA ED glass launches Vanguard optical design above the competition, ensuring brightness and clarity even in the lowest light.



## WATERPROOF & FOGPROOF

Vanguard's O-ring seals completely prevent moisture, dust, and debris from entering the optics. Nitrogen purging prevents fogging in extreme weather conditions.



## PREMIUM ED GLASS

Vanguard's Extra-low Dispersion (ED) glass significantly reduces chromatic aberrations, allowing clear, sharp viewing with high contrast



## LOCKING DIOPTRER RING

The diopter lets users adjust the focus to accommodate differences between each of their eyes. The diopter rings lock so that adjustments don't need to be made before each use.



## SK-15 PRISMS

Exceeding BAK4 prisms in image quality, SK15 minimizes undesirable internal reflections and light rays resulting in increased edge-to-edge brightness and clarity.



## 2&3 STAGE TWIST EYE CUPS

Vanguard's twist-up eye cups come in 2 or 3 stage adjustments, allowing a customized fit for a comfortable viewing experience with or without eyeglasses.



## MULTIGUARD® COATINGS

Vanguard's MultiGuard® coatings provide multiple layers of anti-reflective compounds resulting in optimal light transmission and producing a remarkably clear field of view.



## LOW LIGHT PERFORMANCE

The fully multicoated lenses improve light transmission for bright and clear images, with greater low-light performance.



## RAPID FOCUS EYEPIECE

The rapid focus eyepiece can be adjusted in seconds, giving you a clear and crisp view of your target.



## TRIPOD MOUNTABLE

With the tripod mountable feature, you can easily mount your optics to any tripod or monopod for hands-free stable viewing



## TILT RANGE ±15°

Release the latch and level the hemisphere. Tilt to ± 15 °



## CNC

The tripod is made of high-quality materials and processed by CNC, which delivers excellent strength and durability, and can withstand challenges in various usage environments

ABOUT VANGUARD ----- 2  
 FACTORY ----- 4  
 KEY FEATURES ----- 6  
 CONTENTS ----- 7  
 NEW PRODUCT PAGE ----- 8  
 SPEC SHEET ----- 96

## TRIPODS

ALTA PRO 3VRL AT/CT Video Tripods ----- 12  
 ALTA PRO 3VL AV/CV Video Tripods ----- 14  
 ALTA PRO 3VLT AV/CV Video Tripods ----- 16  
 VEO 5 AV/CV Full Size Video Tripods ----- 18  
 VESTA GO AV/CV Video Travel Tripods ----- 20  
 VEO 3+ MACC Tripods ----- 24  
 VEO 3T+ MACC Travel Tripods ----- 26  
 VEO 5 Traditional Full Size Tripods ----- 28  
 VESTA GO AB/CB Traditional Travel Tripods ----- 30  
 VESTA GO AP/CP Traditional Travel Tripods ----- 31  
 VESTA GO T Table Tripods ----- 32  
 VESTA TT1 Table Tripods ----- 33  
 VS-82 Table Tripods ----- 33  
 VESTA Traditional Tripods ----- 34  
 VEO 2S ----- 35  
 VEO2 PH ----- 36  
 VEO MT-12 ----- 37  
 VEO PV ----- 38  
 ALTA BH ----- 39  
 VEO BH ----- 39  
 VEO PH ----- 40  
 VEO QS-360 ----- 42  
 VEO PA-10 / VEO BT-11 ----- 42  
 QUICK SHOES ----- 43  
 VEO CP KIT / CP / SPH ----- 44  
 VEO CSM / TSA / TC ----- 45

## BAGS

ALTA SKY ----- 48  
 VEO ACTIVE ----- 50  
 VEO SELECT ----- 52  
 VEO CITY ----- 58  
 VEO ADAPTOR ----- 62  
 VEO GO ----- 64  
 VESTA ASPIRE ----- 66  
 VEO BIB F ----- 68  
 VEO BIB T ----- 69  
 VEO BIB DIVIDER S ----- 70  
 DIVIDER BAG ----- 71  
 SUPREME ----- 72  
 ALTA ACCESSORIES ----- 73

## OPTICS

VEO HD IV spotting scopes ----- 78  
 VEO HD spotting scopes ----- 80  
 VESTA spotting scopes ----- 81  
 VEO HD IV Binoculars ----- 82  
 VEO HD 2 Binoculars ----- 83  
 VEO HD Binoculars ----- 84  
 VEO ED Binoculars ----- 85  
 VEO XF Binoculars ----- 86  
 VESTA Binoculars ----- 87  
 VESTA Compact Binoculars ----- 88  
 VEO HD2 1042M Monocular ----- 89  
 VEO ED 8420M Monocular ----- 90  
 VESTA 8320M Monocular ----- 91  
 OPTICS ACCESSORIES ----- 92  
 QUICK RELEASE HARNESS SYSTEM ----- 93

ALTA PRO 3VL AV/CV



P14

ALTA PRO 3VLT AV/CV

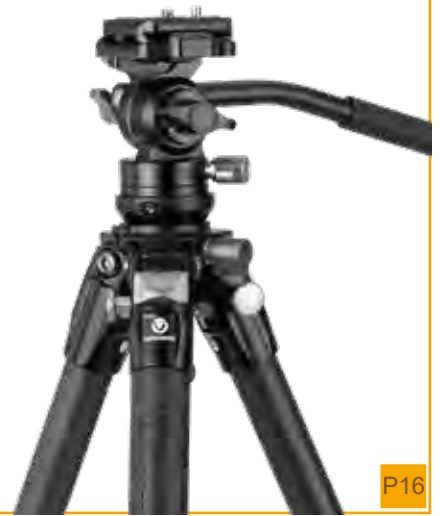

P16

VEO PV 16



P38

VEO PV 14



P38

VEO PV 12



P38

VEO PV 10



P38

“ INNOVATION 2024 ”

Vanguard listens to the voices of consumers and continuously invests in research and development to provide an excellent experience and lasting relationships with our customers.



VANGUARD



VEO 5 AV/CV



P18

VESTA GO AV/CV



P20

VEO 5 AB/CB



P28

VEO 5 APS/CPS



P29

VESTA GO AB/CB



P30

VEO HD IV



P78

ALTA SKY 62/42



P48

VEO CITY B



P58

VEO CITY S



P59

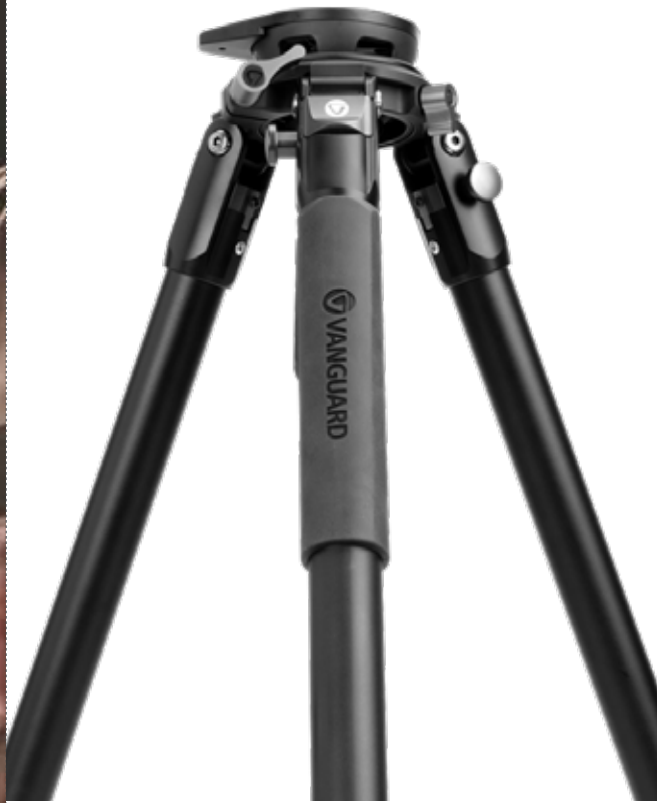

## ALTA PRO 3VRL *New*

Full sized video tripods with a removable levelling system

- ALTA PRO 3VRL 304AT
- ALTA PRO 3VRL 304CT
- ALTA PRO 3VRL 303AT
- ALTA PRO 3VRL 303CT

## ALTA PRO 3VL *New*

Full sized and travel sized tripods with a fixed levelling system

### Full Sized:

- ALTA PRO 3VL 264AV16
- ALTA PRO 3VL 264CV16
- ALTA PRO 3VL 264AV14
- ALTA PRO 3VL 264CV14
- ALTA PRO 3VL 304AT
- ALTA PRO 3VL 304CT
- ALTA PRO 3VL 264AT
- ALTA PRO 3VL 264CT

### Travel Sized:

- ALTA PRO 3VLT 235AV12
- ALTA PRO 3VLT 235CV12
- ALTA PRO 3VLT 235AV10
- ALTA PRO 3VLT 235CV10



## VEO 5 *New*

Full sized video tripods with a traditional central column

- VEO 5 264AV16
- VEO 5 264CV16
- VEO 5 264AV14
- VEO 5 264CV14



## VESTA GO *New*

Travel sized video tripods with a traditional central column

- VESTA GO 264AV12
- VESTA GO 264CV12
- VESTA GO 234AV10
- VESTA GO 234CV10

video  
g system

# VIDEO TRIPODS ALTA PRO 3VRL AT/CT

Explore Your World

Vanguard's Alta Pro series is back with a new generation of professional quality video kits. The Alta Pro 3VRL series features a removable levelling base with a comfortable hand grip on the underside for ultimate control and flexibility. Precision engineered, CNC-machined parts mean that your Alta Pro tripod is built to last with easy-twist leg locks that let you quickly deploy your aluminum or carbon-fiber legs. Plus, retractable steel spikes in the feet let you adapt well on any terrain. It also includes a lightweight platform that can replace the levelling system and be used to attach a dual axis ball or gimbal head to turn it into a great full sized camera tripod.



**New**

## INCLUDES



Up to 30mm leg diameter

75mm removable levelling base +/-15°

\* ALTA PRO 3VRL 304AT



# SERIES HIGHLIGHTS

Explore Your World

- 75mm levelling base +/-15°
- Levelling base is removable
- Retractable steel spikes
- 3-leg angles (23°, 50°, 80°)
- Removable hook
- Solid, easy clean twist locks
- 1 bubble level
- 3/8" threads to attach support arms
- Luxury padded shoulder bag

## CAN BE PURCHASED SEPARATELY IN THE AREA

### ALTA PRO 3VRL PLATFORM 30

Platform adapter for 75mm bowl tripod



ø79mm

### ALTA PRO 3VRL LVL 30

Leveling half ball adapter for 75mm bowl models



### ALTA PRO 3VRL CC 30

Center column for 79mm bowl tripod



MODEL	LENGTH [ INCHES / MM ]	WIDTH [ INCHES / MM ]	BASE [ INCHES / MM ]	WEIGHT [ LBS / G ]
ALTA PRO 3VRL PLATFORM 30	3.11 / 79	0.94 / 24	/	0.19 / 87.6
ALTA PRO 3VRL LVL 30	8.54 / 217	4.06 / 103	2.95 / 75	0.93 / 420
ALTA PRO 3VRL CC 30	15.31 / 389	3.11 / 79	2.28 / 58	0.82 / 370

MODEL	LEG MATERIAL	FOLDED HT. [ INCHES / MM ]	EXTENDED HT. [ INCHES / MM ]	MINIMUM HT. [ INCHES / MM ]	LEG DIAM. [ MM ]	LEG SECT.	HEAD	QUICK SHOE	MAX LOAD [ LBS / KG ]	WEIGHT [ LBS / G ]
ALTA PRO 3VRL 304AT	ALUMINUM	23.86 / 606	62.99 / 1600	8.66 / 220	30	4	/	/	55.1 / 25	5.36 / 2430
ALTA PRO 3VRL 303AT	ALUMINUM	29.88 / 759	66.93 / 1700	7.09 / 180	30	3	/	/	55.1 / 25	5.38 / 2440
ALTA PRO 3VRL 304CT	CARBON FIBER	23.86 / 606	62.99 / 1600	8.66 / 220	30	4	/	/	55.1 / 25	4.58 / 2080
ALTA PRO 3VRL 303CT	CARBON FIBER	29.88 / 759	66.93 / 1700	7.09 / 180	30	3	/	/	55.1 / 25	4.60 / 2085

# VIDEO TRIPODS ALTA PRO 3VL AV/CV 14/16

Explore Your World

Vanguard's Alta Pro series is back with a new generation of professional-quality video tripod kits. Alta Pro 3VL full sized video kits tripods feature a levelling base for smooth and adaptable control and flexibility. A spring-action video pan head gives you fluid motion and smooth panning and tilting, along with precise control with comfortable handle control. Precision engineered, CNC-machined parts mean that your Alta Pro tripod is built to last with easy-twist leg locks that let you quickly deploy your aluminum or carbon-fiber legs. Plus, retractable steel spikes in the feet let you adapt well on any terrain.



**New**



Up to 30mm leg diameter

Locking tilt knob

**±15°**

50mm half ball levelling base ±15° (26 pipe diameter only)

\* ALTA PRO 3VL 264AV16



# SERIES HIGHLIGHTS

Explore Your World

- Half ball levelling base ±15°
- Counterbalancing head tilt
- Retractable steel spikes
- 3-leg angles (23°, 50°, 80°)
- Removable hook
- Solid, easy clean twist locks
- 1 bubble levels
- 1/4" threads to attach support arms
- Luxury padded shoulder bag



Rubber feet change to spikes with a few turns, for maximum stability on multiple terrain types



MODEL	LEG MATERIAL	FOLDED HT. [INCHES / MM]	EXTENDED HT. [INCHES / MM]	MINIMUM HT. [INCHES / MM]	LEG DIAM. [MM]	LEG SECT.	HEAD	QUICK SHOE	MAX LOAD [LBS / KG]	WEIGHT [LBS / G]
ALTA PRO 3VL 304AT	ALUMINUM	21.97 / 558	60.04 / 1525	5.59 / 142	30	4	/	/	28.65 / 13	3.77 / 1710
ALTA PRO 3VL 264AVI6	ALUMINUM	25.47 / 647	62.8 / 1582	9.61 / 244	26	4	VEO PV-16	QS-71P	22.04 / 10	442 / 2006
ALTA PRO 3VL 264AVI4	ALUMINUM	24.8 / 630	6.61 / 1565	8.94 / 227	26	4	VEO PV-14	QS-71P	17.63 / 8	4.11 / 1864
ALTA PRO 3VL 264AT	ALUMINUM	21.26 / 540	58.07 / 1475	5.39 / 137	26	4	/	/	22.04 / 10	2.91 / 1320
ALTA PRO 3VL 304CT	CARBON FIBER	21.97 / 558	60.04 / 1525	5.59 / 142	30	4	/	/	28.65 / 13	3.15 / 1430
ALTA PRO 3VL 264CVI6	CARBON FIBER	25.47 / 647	62.8 / 1582	9.61 / 244	26	4	VEO PV-16	QS-71P	22.04 / 10	3.80 / 1726
ALTA PRO 3VL 264CVI4	CARBON FIBER	24.8 / 630	6.61 / 1565	8.94 / 227	26	4	VEO PV-14	QS-71P	17.63 / 8	3.49 / 1584
ALTA PRO 3VL 264CT	CARBON FIBER	21.26 / 540	58.07 / 1475	5.39 / 137	26	4	/	/	22.04 / 10	2.29 / 1040



# VIDEO TRIPODS ALTA PRO 3VLT AV/CV 12/10

Explore Your World

Vanguard's Alta Pro series is back with a new generation of professional-quality video tripod kits. The Alta Pro 3VLT series features a more compact design and a levelling base for ultimate control and flexibility, along with maximum portability. A compact video pan head gives you spring-assisted tilting and smooth panning, along with easy-to-use handles. Precision engineered, CNC-machined parts mean that your Alta Pro tripod is built to last with easy-twist leg locks that let you quickly deploy your aluminum or carbon-fiber legs. Plus, retractable steel spikes in the feet let you adapt well on any terrain.



**New**

45mm half-ball levelling base with  $\pm 15^\circ$  movement



Ultra compact

**60MM**  
diameter

23mm

20mm

17mm

14mm

11mm



\*ALTA PRO 3VLT 235CV12





# SERIES HIGHLIGHTS

Explore Your World

- 45mm half ball levelling base ±15°
- Spring-assisted head tilt
- Spring-assisted head tilt
- 3-leg angles (23°, 50°, 80°)
- Removable hook
- Rubber and spiked feet
- 1 bubble level
- 1/4" threads to attach support arms
- Luxury padded shoulder bag



Spring-assisted heads provide fluid motion, easy balancing, and smooth tilting and panning

Designed to be more travel-friendly than the average video tripod without sacrificing functionality and stability



"Open" video head with one support point (VEO PV-12)



"Closed" video head with two support points (VEO PV-10)



## Lightweight

MODEL	LEG MATERIAL	FOLDED HT. [INCHES / MM]	EXTENDED HT. [INCHES / MM]	MINIMUM HT. [INCHES / MM]	LEG DIAM. [MM]	LEG SECT.	HEAD	QUICK SHOE	MAX LOAD [LBS / KG]	WEIGHT [LBS / G]
ALTA PRO 3VLT 235AVI2	ALUMINUM	21.22 / 539	58.23 / 1479	7.56 / 192	23	5	VEO PV-12	QS-55P	13.22 / 6	2.72 / 1235
ALTA PRO 3VLT 235AVI0	ALUMINUM	21.22 / 539	58.23 / 1479	7.56 / 192	23	5	VEO PV-10	QS-55P	11.02 / 5	2.80 / 1269
ALTA PRO 3VLT 235CVI2	CARBON FIBER	21.22 / 539	58.23 / 1479	7.56 / 192	23	5	VEO PV-12	QS-55P	13.22 / 6	2.55 / 1155
ALTA PRO 3VLT 235CVI0	CARBON FIBER	21.22 / 539	58.23 / 1479	7.56 / 192	23	5	VEO PV-10	QS-55P	11.02 / 5	2.62 / 1189

# FULL SIZE VIDEO TRIPODS **VEO 5 AV/CV**

Explore Your World

VEO 5 video tripods are CNC-machined to be lightweight but deliver excellent stability. VEO 5 AV and CV models come with a smooth Arca-compatible video head. The long handle, adjustable fluid movement, and pan and tilting locking knobs deliver maximum control for capturing video or photos.



**New**



**360°**



3/8" screw hole

Rubber feet change to spikes with a few turns, for maximum stability on multiple terrain types



\* VEO 5 264AV14





# SERIES HIGHLIGHTS

Explore Your World

- Hexagonal central column to make it more compact when folded
- Center column converts to a short column for low-angle shots
- 3-leg angles (23°, 50°, 80°)
- Solid, easy clean twist locks
- 3/8" threads to attach support arms
- Luxury padded shoulder bag



Spring-assisted heads provide fluid motion, easy balancing, and smooth tilting and panning

Hexagonal central column allows the tripod legs to fold in to 93mm/3.6 inch for maximum portability



"Open" video head with one support point (VEO PV-16)



"Closed" video head with two support points (VEO PV-14)

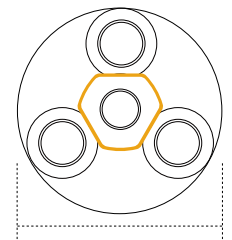

92.5mm/3.64 in.

MODEL	LEG MATERIAL	FOLDED HT. [INCHES / MM]	EXTENDED HT. [INCHES / MM]	STANDARD HT. [INCHES / MM]	LEG DIAM. [MM]	LEG SECT.	HEAD	QUICK SHOE	MAX LOAD [LBS / KG]	WEIGHT [LBS / G]
VEO 5 264AVI6	ALUMINUM	23.07 / 602	66.81 / 1697	56.38 / 1432	26	4	VEO PV-16	QS-71P	22.04 / 10	4.95 / 2246
VEO 5 264AVI4	ALUMINUM	22.64 / 575	66.14 / 1680	55.71 / 1415	26	4	VEO PV-14	QS-71P	17.6 / 8	4.64 / 2103
VEO 5 264CVI6	CARBON FIBER	23.07 / 602	66.81 / 1697	56.38 / 1432	26	4	VEO PV-16	QS-71P	22.04 / 10	4.33 / 1966
VEO 5 264CVI4	CARBON FIBER	22.64 / 575	66.14 / 1680	55.71 / 1415	26	4	VEO PV-14	QS-71P	17.6 / 8	4.02 / 1823

# VIDEO TRAVEL TRIPODS VESTA GO AV/CV

Explore Your World

The Vesta GO series excels when packability and portability are key. This lightweight and compact tripod series is easy to stow away for long days out, yet they do not compromise on performance. With three easy-set leg angles and a split center column, you can use the tripod while standing, sitting, or setting up near the ground for low-angle or macro shots. Vesta GO AV and CV models include an Arca-compatible, counterbalanced video head for ultra-smooth tilting and panning.



**New**



Smartphone holder



VEO PV-12 head 335g/0.74lbs  
VEO PV-10 head 367g/0.81lbs



Designed to be compact when folded for excellent portability

\* VESTA GO 234AV10



# SERIES HIGHLIGHTS

Explore Your World

- Lightweight and compact tripod
- Fluid 2-way pan head
- Rubber feet
- 3-leg angles (20°, 50°, 80°)
- Removable hook
- Includes smartphone holder
- 3/8" to 1/4" connecting head screw
- Threads to attach support arms
- Padded shoulder bag



Center column converts to a short column for low-angle shots

Carbon-fiber models include silent, easy set twist leg locks; aluminum models come with fast-flip leg locks



MODEL	LEG MATERIAL	FOLDED HT. [INCHES / MM]	EXTENDED HT. [INCHES / MM]	STANDARD HT. [INCHES / MM]	LEG DIAM. [MM]	LEG SECT.	HEAD	QUICK SHOE	MAX LOAD [LBS / KG]	WEIGHT [LBS / G]
VESTA GO 264AVI2	ALUMINUM	18.31 / 465	64.53 / 1639	52.44 / 1332	26	4	VEO PV-12	QS-55P	13.22 / 6	3.71 / 1685
VESTA GO 234AVI0	ALUMINUM	17.13 / 435	59.41 / 1509	48.50 / 1232	23	4	VEO PV-10	QS-55P	11.02 / 5	3.45 / 1567
VESTA GO 264CVI2	CARBON FIBER	18.31 / 465	64.53 / 1639	52.44 / 1332	26	4	VEO PV-12	QS-55P	13.22 / 6	3.01 / 1365
VESTA GO 234CVI0	CARBON FIBER	17.13 / 435	59.41 / 1509	48.50 / 1232	23	4	VEO PV-10	QS-55P	11.02 / 5	3.12 / 1417

# PHOTO TRIPODS



## MULTI-ANGLE CENTRAL COLUMN TRIPODS

### VE03+

Full Sized:

- VE03+ 303ABS
- VE03+ 303ABS
- VE03+ 263AB160S
- VE03+ 263CB160S
- VE03+ 263APS
- VE03+ 263CPS
- VE03+ 303AT
- VE03+ 303CT

### VE03T+

Travel Sized

- VE03T+ 234AB
- VE03T+ 234CB



## TRADITIONAL FULL SIZE TRIPODS

### VEO 5 *New*

- VEO 5 304AB250S
- VEO 5 304CB250S
- VEO 5 264AB160S
- VEO 5 264CB160S
- VEO 5 234AB110S
- VEO 5 234CB110S
- VEO 5 304AT
- VEO 5 304CT
- VEO 5 264APS38
- VEO 5 264CPS38
- VEO 5 234APS36
- VEO 5 234CPS36

## TRADITIONAL TRAVEL TRIPODS

### VESTA GO *New*

- VESTA GO 264AP
- VESTA GO 264CP
- VESTA GO 234AP
- VESTA GO 234CP
- VESTA GO 204AP
- VESTA GO 204CP
- VESTA GOT 233AP
- VESTA GOT 233CP
- VESTA GOT 203AB
- VESTA GO 264AB
- VESTA GO 264CB
- VESTA GO 234AB
- VESTA GO 234CB
- VESTA GO 204AB
- VESTA GO 204CB

# MACC FULL SIZE TRIPODS VEO 3+

Explore Your World

VEO 3+ is an all-in-one tripod series that is sturdy and trustworthy but truly shines thanks to its outstanding versatility. The easy-to-operate Multi-Angle Central Column (MACC) can be almost 360° in any direction, making it perfect for any style of photography -- enjoy moving from macro to landscape in seconds. You can also use the MACC as a multi-mount when you pair it with the VEO+ MA1 Adaptor (provided). Attach additional equipment to the tripod to enhance any shot. Additionally, VEO 3+ 26mm models include a leg that converts to a monopod, a premium Arca-compatible ball or pan head (depending on model), and removable spiked feet.

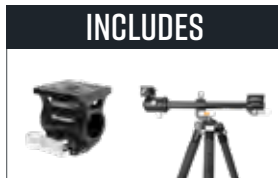

Innovative Multi-Angle Central Column (MACC) System allows users to move the central column almost 360° in any direction, to get to the best position for your photo with ease



Dual-axis ball heads for maximum control



Up to 30mm leg diameter

\* VEO 3+303ABS





# SERIES HIGHLIGHTS

Explore Your World

- Multi-Angle Central Column (MACC)
- 3-leg angles (23°, 50°, 80°)
- Arca compatible 3-way pan/ball heads
- MACC converts to a Multi-Mount
- Removable spiked feet
- Leg that converts to onopod(26mm only)
- Max load capacity up to 25kg/55lbs
- Extends up to 1774mm/69.8 inches
- Luxury padded shoulder bag



Head: VEO BH-250S/160S  
Quick shoe: QS-62v3

VEO 3+ 303ABS/CBS  
VEO 3+ 263AB160S/CB160S



Head: VEO PH-38S  
Quick shoe: QS-74

VEO 3+ 263APS/CPS

## MULTI-MOUNT ADAPTER FOR ADDITIONAL EQUIPMENT

After the center column/tube is set horizontally, load the included VEO+MA1 adapter onto the tube to hold an additional camera, monitor, spotting scope, or other equipment. The tube is marked with scales for precise positioning along the smooth surface.



MODEL	LEG MATERIAL	FOLDED HT. [ INCHES / MM ]	EXTENDED HT. [ INCHES / MM ]	STANDARD HT. [ INCHES / MM ]	LEG DIAM. [ MM ]	LEG SECT.	HEAD	QUICK SHOE	MAX LOAD [ LBS / KG ]	WEIGHT [ LBS / G ]
VEO 3+ 303ABS	ALUMINUM	31.14 / 791	69.84 / 1774	59.57 / 1513	30	3	VEO BH-250S	QS-62V3	55.1 / 25	6.47 / 2935
VEO 3+ 303AT	ALUMINUM	26.38 / 670	65.08 / 1653	54.80 / 1392	30	3	/	/	55.1 / 25	5.05 / 2292
VEO 3+ 263ABI60S	ALUMINUM	30.47 / 774	68.46 / 1739	58.43 / 1484	26	3	VEO BH-160S	QS-62V3	33.1 / 15	5.50 / 2497
VEO 3+ 263APS	ALUMINUM	30.71 / 780	68.31 / 1735	58.27 / 1480	26	3	VEO PH-38S	QS-74	22.0 / 10	5.96 / 2705
VEO 3+ 303CBS	CARBON FIBER	31.14 / 791	69.84 / 1774	59.57 / 1513	30	3	VEO BH-250S	QS-62V3	55.1 / 25	5.70 / 2588
VEO 3+ 303CT	CARBON FIBER	26.38 / 670	65.08 / 1653	54.80 / 1392	30	3	/	/	55.1 / 25	4.29 / 1945
VEO 3+ 263CBI60S	CARBON FIBER	30.47 / 774	68.46 / 1739	58.43 / 1484	26	3	VEO BH-160S	QS-62V3	33.1 / 15	4.79 / 2172
VEO 3+ 263CPS	CARBON FIBER	30.71 / 780	68.31 / 1735	58.27 / 1480	26	3	VEO PH-38S	QS-74	22.0 / 10	5.12 / 2322

# **MAGC TRAVEL TRIPODS VEO 3T+**

Explore Your World

The VEO3T+ includes the same innovative features as the VEO3+ with a 10kg/22lbs load capacity, but in a more compact travel size. Folding to just 46cm allows the VEO 3T+ to fit into almost any hand luggage and means that you don't have to compromise your photography style when you arrive at your destination.



## INCLUDES

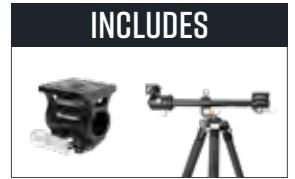

\*VEO 3T+ 234AB



# SERIES HIGHLIGHTS

Explore Your World

- Multi-Angle Central Column (MACC)
- MACC converts to a Multi-Mount
- Solid, easy clean twist locks
- 3-leg angles (23°, 50°, 80°)
- Removable hook
- Removable spiked feet
- 3/8" threads to attach support arms
- Leg that converts to monopod
- Luxury padded shoulder bag

## ARCA COMPATIBLE DUAL AXIS BALL HEADS

Level your tripod in seconds on any terrain for panoramas

Quick shoe: QS-62v3



No need to spend time fiddling with tripod legsto level the traditionalpan axis

VEO 3T+ 234AB/CB



## ONE LEG CAN BE USED AS A MONOPOD

## TRAVEL SIZE - UNDER 460MM / 18.11 INCH



This item  
Veos select rolling bags

MODEL	LEG MATERIAL	FOLDED HT. [ INCHES / MM ]	EXTENDED HT. [ INCHES / MM ]	STANDARD HT. [ INCHES / MM ]	LEG DIAM. [ MM ]	LEG SECT.	HEAD	QUICK SHOE	MAX LOAD [ LBS / KG ]	WEIGHT [ LBS / G ]
VEO 3T+ 234AB	ALUMINUM	18.11 / 460	57.48 / 1460	48.23 / 1225	23	4	VEO BH-110S	QS-62V3	22.0 / 10	6.47 / 2190
VEO 3T+ 234CB	CARBON FIBER	18.11 / 460	57.48 / 1460	48.23 / 1225	23	4	VEO BH-110S	QS-62V3	22.0 / 10	5.70 / 1978

# TRADITIONAL FULL SIZE TRIPODS VEO 5

Explore Your World

VEO 5 tripods are designed to be lightweight for easy carrying, but also deliver all the great features you love about Vanguard tripods. These full-size tripods come in models with no heads, pan heads, or dual-axis ball heads, which gives you the choice to adapt your gear to your needs. Retractable spiked feet help you maximise your stability on any terrain.



**New**



**38~90°**



Center column locking knob

Rubber feet change to spikes with a few turns for maximum stability on multiple terrain types

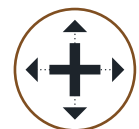

Up to 30mm leg diameter

\*VEO 5 304AB250S



# SERIES HIGHLIGHTS

Explore Your World

- Hexagonal central column to make it more compact when folded
- Center column converts to a short column for low-angle shots
- 3/8" to 1/4" -20 Reversible Screw Adaptor
- Solid, easy clean twist locks
- 3/8" threads to attach support arms
- Luxury padded shoulder bag



Head: VEO BH-250S  
/160S/110S  
Quick shoe: QS-62V3

VEO 5 304AB/CB250S  
VEO 5 264AB/CB160S  
VEO 5 234AB/CB110S



Head: VEO PH-38S/36S  
Quick shoe: QS-74

VEO 5 264APS/CPS38  
VEO 5 234APS/CPS36

Center column converts to a short column  
for low-angle shots



Deluxe padded carrying bag included



MODEL	LEG MATERIAL	FOLDED HT. [INCHES / MM]	EXTENDED HT. [INCHES / MM]	STANDARD HT. [INCHES / MM]	LEG DIAM. [MM]	LEG SECT.	HEAD	QUICK SHOE	MAX LOAD [LBS / KG]	WEIGHT [LBS / G]
VEO 5 304AB250S	ALUMINUM	25.16 / 639	70.31 / 1786	60.08 / 1526	30	4	VEO BH-250S	QS-62V3	44.08 / 20	5.45 / 2473
VEO 5 304AT	ALUMINUM	20.39 / 518	65.55 / 1665	55.31 / 1405	30	4	/	/	44.08 / 20	4.03 / 1830
VEO 5 264AB160S	ALUMINUM	23.86 / 606	66.97 / 1701	56.73 / 1441	26	4	VEO BH-160S	QS-62V3	33.06 / 15	4.52 / 2050
VEO 5 234AB110S	ALUMINUM	22.64 / 575	63.78 / 1620	53.54 / 1360	23	4	VEO BH-110S	QS-62V3	22.04 / 10	3.67 / 1667
VEO 5 264APS38	ALUMINUM	23.90 / 607	67.01 / 1702	56.77 / 1442	26	4	VEO PH-38S	QS-74	22.04 / 10	4.86 / 2204
VEO 5 234APS36	ALUMINUM	22.87 / 581	64.02 / 1626	53.78 / 1366	23	4	VEO PH-36S	QS-74	12.22 / 6	3.98 / 1808
VEO 5 304CB250S	CARBON FIBER	25.16 / 639	70.31 / 1786	60.08 / 1526	30	4	VEO BH-250S	QS-62V3	44.08 / 20	4.75 / 2153
VEO 5 304CT	CARBON FIBER	20.39 / 518	65.55 / 1665	55.31 / 1405	30	4	/	/	44.08 / 20	3.33 / 1510
VEO 5 264CB160S	CARBON FIBER	23.86 / 606	66.97 / 1701	56.73 / 1441	26	4	VEO BH-160S	QS-62V3	33.06 / 15	3.90 / 1770
VEO 5 234CB110S	CARBON FIBER	22.64 / 575	63.78 / 1620	53.54 / 1360	23	4	VEO BH-110S	QS-62V3	22.04 / 10	1587 / 3.50
VEO 5 264CPS38	CARBON FIBER	23.90 / 607	67.01 / 1702	56.77 / 1442	26	4	VEO PH-38S	QS-74	22.04 / 10	4.24 / 1924
VEO 5 234CPS36	CARBON FIBER	22.87 / 581	64.02 / 1626	53.78 / 1366	23	4	VEO PH-36S	QS-74	12.22 / 6	3.81 / 1728

# TRADITIONAL TRAVEL TRIPODS VESTA GO AB/CB Explore Your World

The Vesta GO series excels when packability and portability are key. This lightweight and compact tripod series is easy to stow away for long days afield, yet they do not compromise on performance. With three easy-set leg angles and a split center column, you can use the tripod while standing, sitting, or prone.



**New**



**INCLUDES**



Smartphone holder



VEO BH-60/50/45  
Arca-compatible ball head  
Quick shoe: QS-74

## SERIES HIGHLIGHTS

- Lightweight and compact tripod
- 3-leg angles (20°, 50°, 80°)
- Smartphone holder
- Threads to attach support arms
- Carbon-fiber models include silent, easy-twist leg locks; aluminum models come with fast-flip leg locks



\*VESTA GO 234CB

MODEL	LEG MATERIAL	FOLDED HT. [INCHES / MM]	EXTENDED HT. [INCHES / MM]	STANDARD HT. [INCHES / MM]	LEG DIAM. [MM]	LEG SECT.	HEAD	QUICK SHOE	MAX LOAD [LBS / KG]	WEIGHT [LBS / G]
VESTA GO 264AB	ALUMINUM	17.32 / 440	63.58 / 1615	53.74 / 1365	26	4	VEO BH-60	QS-74	22.04 / 10	3.89 / 1767
VESTA GO 234AB	ALUMINUM	15.94 / 405	58.82 / 1494	49.06 / 1246	23	4	VEO BH-50	QS-74	9.9 / 4.5	2.87 / 1300
VESTA GO 204AB	ALUMINUM	15.16 / 385	54.53 / 1385	44.72 / 1136	20	4	VEO BH-45	QS-74	6.6 / 3	2.87 / 1130
VESTA GO 264CB	CARBON FIBER	17.32 / 440	63.58 / 1615	53.74 / 1365	26	4	VEO BH-60	QS-74	22.04 / 10	3.19 / 1447
VESTA GO 234CB	CARBON FIBER	15.94 / 405	58.82 / 1494	49.06 / 1246	23	4	VEO BH-50	QS-74	9.9 / 4.5	2.53 / 1150
VESTA GO 204CB	CARBON FIBER	15.16 / 385	54.53 / 1385	44.72 / 1136	20	4	VEO BH-45	QS-74	6.6 / 3	2.05 / 930



# TRADITIONAL TRAVEL TRIPODS VESTA GO AP/CP Explore Your World

The Vesta GO series excels when portability is key. This lightweight and compact tripod series is easy to stow away for long days out shooting photos or videos, yet they do not compromise on performance. With three easy-set leg angles and a split center column, you can use the tripod while standing, sitting, or down low. Vesta GO AP and CP models include an Arca-compatible 2-way pan head with smooth motion with a separate pan lock, and the tilt lock control in the handle. This makes it intuitive to follow a moving subject, whether taking video on your camera or smartphone, or observing with a spotting scope.



**New**

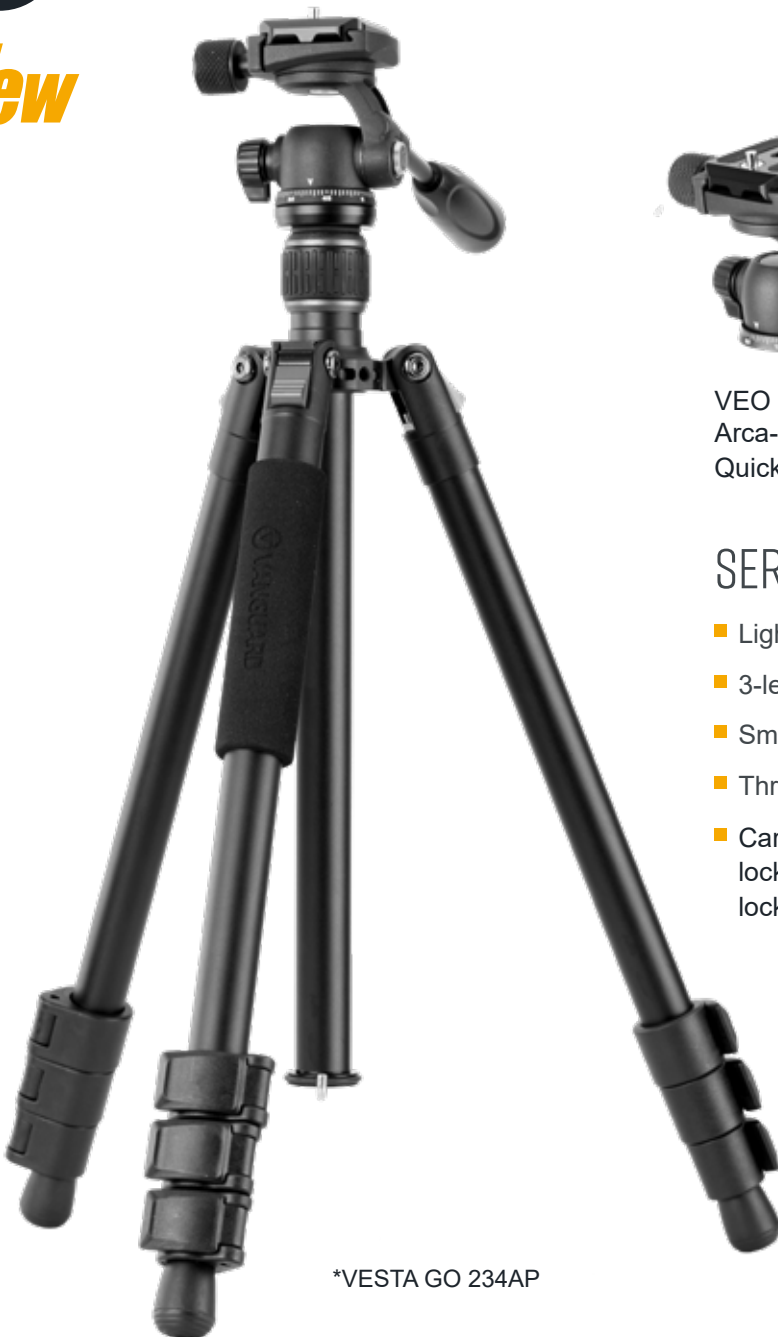

\*VESTA GO 234AP



**INCLUDES**  
Smartphone holder



VEO PH-24  
Arca-compatible 2-way pan head  
Quick shoe: QS-55P

## SERIES HIGHLIGHTS

- Lightweight and compact tripod
- 3-leg angles (20°, 50°, 80°)
- Smartphone holder
- Threads to attach support arms
- Carbon-fiber models include silent, easy-twist leg locks; aluminum models come with fast-flip leg locks



MODEL	LEG MATERIAL	FOLDED HT. [INCHES / MM]	EXTENDED HT. [INCHES / MM]	STANDARD HT. [INCHES / MM]	LEG DIAM. [MM]	LEG SECT.	HEAD	QUICK SHOE	MAX LOAD [LBS / KG]	WEIGHT [LBS / G]
VESTA GO 264AP	ALUMINUM	18.70 / 475	65.51 / 1664	52.24 / 1327	26	4	VEO PH-24	QS-55P	6.6 / 3	3.78 / 1715
VESTA GO 234AP	ALUMINUM	17.52 / 445	60.59 / 1539	48.31 / 1227	23	4	VEO PH-24	QS-55P	6.6 / 3	3.23 / 1465
VESTA GO 204AP	ALUMINUM	16.14 / 410	55.28 / 1404	44.29 / 1125	20	4	VEO PH-24	QS-55P	6.6 / 3	2.85 / 1295
VESTA GO 264CP	CARBON FIBER	18.70 / 475	65.51 / 1664	52.24 / 1327	26	4	VEO PH-24	QS-55P	6.6 / 3	3.07 / 1395
VESTA GO 234CP	CARBON FIBER	17.52 / 445	60.59 / 1539	48.31 / 1227	23	4	VEO PH-24	QS-55P	6.6 / 3	2.90 / 1315
VESTA GO 204CP	CARBON FIBER	16.14 / 410	55.28 / 1404	44.29 / 1125	20	4	VEO PH-24	QS-55P	6.6 / 3	2.41 / 1095

# TABLE TRIPODS VESTA GO T

Explore Your World

When a regular compact tripod is still not compact enough, you can rely on the Vesta GO T series of ultra-packable table tripods. This piece may be small in size, but it is big on performance, with either a ball head or smooth pan head to mount your optics or camera. The legs feature easy-to-use twist locks and are adjustable to 3 angles to set up how you need it.



**New**



\*VEO 3GOT 233AP



Head: VEO PH-24  
Quick shoe: QS-55P



Head: VEO BH-45  
Quick shoe: QS-74

## SERIES HIGHLIGHTS

- Weighs as little as 882g/1.94 lbs
- Max load capacity up to 3kg/6.6lbs
- Arca compatible pan/ball heads
- 3 easy set leg angles (20°, 50° & 80°)
- Hook to attach weight for extra stability
- 3/8" To 1/4" -20 reversible screw adaptor

MODEL	LEG MATERIAL	FOLDED HT. [INCHES / MM]	EXTENDED HT. [INCHES / MM]	STANDARD HT. [INCHES / MM]	LEG DIAM. [MM]	LEG SECT.	HEAD	QUICK SHOE	MAX LOAD [LBS / KG]	WEIGHT [LBS / G]
VESTA GOT 233AP	ALUMINUM	10.24 / 260	22.72 / 577	18.19 / 462	23	3	VEO PH-24	QS-55P	6.6 / 3	2.54 / 1153
VESTA GOT 233CP	CARBON FIBER	10.24 / 260	22.72 / 577	18.19 / 462	23	3	VEO PH-24	QS-55P	6.6 / 3	2.45 / 1112
VESTA GOT 203AB	ALUMINUM	9.49 / 241	21.06 / 535	17.1 / 434	20	3	VEO BH-45	QS-74	6.6 / 3	1.94 / 882



# TABLE TRIPODS VESTA TTI

The VESTA TT1 aluminum table top tripod kit with smart phone holder is a small, ergonomic, stable table top tripod capable of holding smartphones, sport optics, and supporting cameras up to 2kg/4.4 lbs.



Bluetooth remote



Smartphone adapter  
Up to 3.4in/8.7cm

# TABLE TRIPODS VS-82

The VS-82 is a compact, lightweight, and convenient-to-use tabletop tripod. Its 2-way panhead and 360° rotation are ideal for spotting scope or camera use.



360° Swiveling 2-way  
pan head



Adjustable center  
column

MODEL	LEG MATERIAL	FOLDED HT. [INCHES / MM]	EXTENDED HT. [INCHES / MM]	STANDARD HT. [INCHES / MM]	LEG DIAM. [MM]	LEG SECT.	HEAD	QUICK SHOE	MAX LOAD [LBS / KG]	WEIGHT [LBS / G]
VESTA TTI	ALUMINUM	6.89 / 175	3.94 / 100	/	/	1	BALL HEAD	/	44 / 2	0.34 / 156
VS-82	ALUMINUM	9.05 / 230	9.84 / 250	/	/	2	PAN HEAD	/	5.5 / 2.5	0.85 / 390



# TRADITIONAL TRIPODS VESTA

Explore Your World

VESTA tripods are a series of photo and video supports that are designed for creative image-makers or adventurous sporting optics users. Whether you are taking or partaking in the shot, this series is designed to work wherever life takes you. The VESTA Series is Vanguard's entry-level tripod offering and is designed to perform whether you are using smartphones, mirrorless/CSC/hybrid cameras, small DSLR cameras, video camcorders, or sporting optics such as binoculars and spotting scopes.



\*VESTA 203AP



PH-23  
Quick shoe: QS-29



GH-45  
Quick shoe: QS-29

## SERIES HIGHLIGHTS

- 2 bubble levels provide easy leveling of the tripod
- Anti-shock ring effectively reduces impact
- Anti-slip rubber feet designed for all types of terrain
- Top plate can be rotated to set up in a portrait camera position (making it a 3-way pan head) or for 360° Panoramic images
- Adjust, raise or lower the tripod quickly by using the easy-to-adjust quick flip leg locks



MODEL	LEG MATERIAL	FOLDED HT. [INCHES / MM]	EXTENDED HT. [INCHES / MM]	STANDARD HT. [INCHES / MM]	LEG DIAM. [MM]	LEG SECT.	HEAD	QUICK SHOE	MAX LOAD [LBS / KG]	WEIGHT [LBS / G]
VESTA 233AP	ALUMINUM	22.9 / 582	61.0 / 1550	48.1 / 1221	23	3	PH-23	QS-29	7.7 / 3.5	2.8 / 1275
VESTA 203AP	ALUMINUM	22.5 / 570	61.0 / 1550	48.0 / 1220	20	3	PH-23	QS-29	7.7 / 3.5	2.4 / 1105
VESTA 203AGH	ALUMINUM	22.5 / 570	61.0 / 1550	48.5 / 1231	20	3	GH-45	QS-29	7.7 / 3.5	3.0 / 1360



VEO 2S is a collection of monopods designed for travel. This lightweight series works with camera loads up to 15kg/33lbs, and the next-gen monopod does not sacrifice quality or compromise stability. The advance-engineered twist leg locks ensure easy, fast deployment and height adjustments while allowing you to get the shot with your camera or smartphone.



Bluetooth remote



Head: VEO BP-50T  
Quick shoe: QS-72T

## SERIES HIGHLIGHTS

- Arca compatible ball heads with Kit Models
- 4-in-1 quick shoe QS-72T with kit models
- Smartphone adapter included with all TR models
- Folds to 52cm/21 inches
- Weighs as little as 800g/1.75 lbs
- Max load capacity up to 15kg/33lbs

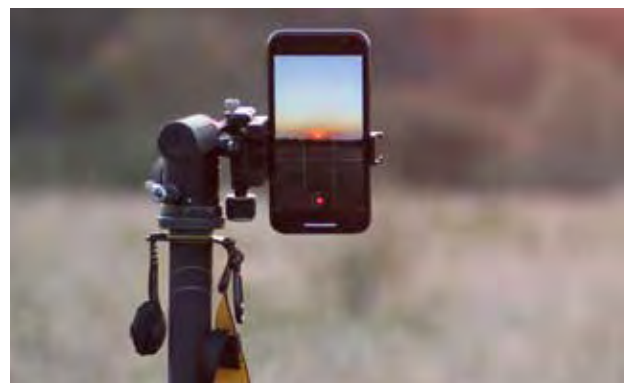

\*VEO 2S CM-264TBP120T

MODEL	LEG MATERIAL	FOLDED HT. [INCHES / MM]	EXTENDED HT. [INCHES / MM]	STANDARD HT. [INCHES / MM]	LEG DIAM. [MM]	LEG SECT.	HEAD	QUICK SHOE	MAX LOAD [LBS / KG]	WEIGHT [LBS / G]
VEO2S AM-234TBP50T	ALUMINUM	23.7 / 604	65.1 / 1654	/	23	4	VEO BP-50T	QS-72T	13.2 / 6	2.8 / 1275
VEO2S AM-264TR	ALUMINUM	21.5 / 545	64.1 / 1630	/	26	4	/	/	33.1 / 15	1.96 / 890
VEO2S AM-234TR	ALUMINUM	20.5 / 520	61.0 / 1550	/	23	4	/	/	22 / 10	1.77 / 805
VEO2S CM-264TBP120T	CARBON FIBER	24.5 / 624	68.0 / 1729	/	26	4	VEO BP-120T	QS-72T	26.5 / 12	2.97 / 1347
VEO2S CM-264TR	CARBON FIBER	21.5 / 545	64.1 / 1630	/	26	4	/	/	33.1 / 15	1.75 / 796



# WINDOW MOUNT VEO2 PH

Explore Your World

With Veo 2 window mounts, you can cover miles of content-worthy terrain without missing the details. Enjoy comfortable and smooth panning and tilting thanks to VEO 2's superior mechanical design and quality components. Clamp onto a vehicle window, a tree branch, a tabletop, or many other surfaces for easy camera setup where a tripod won't do.

**New**



\*VEO2 PH-28WM



\*VEO2 PH-24WM



2-way pan head that is easy to control with one hand, leaving the other hand free to control focus or zoom

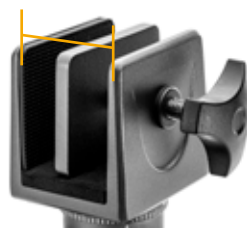

22-29mm clamp range adapts to numerous window or surface types

Spotting scopes with Arca-Swiss-compatible bases can be used without the need for a quick shoe



MODEL	CLAMP WIDTH	FRONTAL TILT °	ROTATION °	QUICK SHOE	MAX LOAD [ LBS / KG ]	WEIGHT [ LBS / G ]
VEO2 PH-28WM	29MM	-60° ~ +90°	360°	QS-6IP	8.8 / 4	1.5 / 711
VEO2 PH-24WM	22MM	-60° ~ +90°	360°	QS-55P	6.6 / 3	1.1 / 537

# MULTI-MOUNT HORIZONTAL ARM VEO MT-12

Explore Your World

The VEO MT-12 is a horizontal arm that will fit to any tripod to allow overhead shots, or to fit accessories to maximize your shoot. Ideal for mounting up to 4 pieces of gear, it features sturdy aluminum alloy material, is 25.6in/650mm long, has a large center locking ring, two safety pins, length adjustment bar, and comes with two VEO+MA1s. If you are looking to mount multiple pieces of gear on a tripod, then look no further -- the VEO MT-12 is your ideal solution.



VEO+MA1

## SERIES HIGHLIGHTS

- Mount up to four devices (such as cameras, microphones, lights, displays, etc.) to a single tripod
- Ends have reversible 3/8" threads to convert to 1/4"
- Locking lever to hold the VEO-MA1 in position
- A stopper on each end prevents gear from sliding off
- Allows you to take overhead shots on any tripod
- Includes two VEO-MA1 mounts to attach/position extra gear

MODEL	FULL EXTENDED HT. [INCHES / MM]	CENTER COLUMN PLATE DIAMETER [INCHES / MM]	MAX LOAD [LBS / KG]	WEIGHT [LBS / G]
VEO MT-12	25.6 / 650	2.28 / 58	22.0 / 10.00	2.2 / 1.0

MODEL	LENGTH [INCHES / MM]	WIDTH [INCHES / MM]	HEIGHT [INCHES / MM]	WEIGHT [LBS / G]
VEO+MA1	2.3 / 58	3.3 / 83	2.7 / 68	0.46 / 0.21

# VIDEO HEAD VEO PV

Explore Your World

VEO PV video heads are CNC-machined to deliver the smoothest movement possible, with dampening knobs that personalize the movement to your need and extended handles for maximum control – plus, a counterbalanced design to keep your camera steady. Each includes an Arca-compatible quick-release plate with a non-twist spring pin that ensures a solid fit to your photo or video gear.

**New**



\*VEO PV-16



\*VEO PV-14



\*VEO PV-12  
ultra-compact



\*VEO PV-10  
ultra-compact



"Open" video head with one support point  
(VEO PV-16 / 12)



"Closed" video head with two support points  
(VEO PV-14/10)

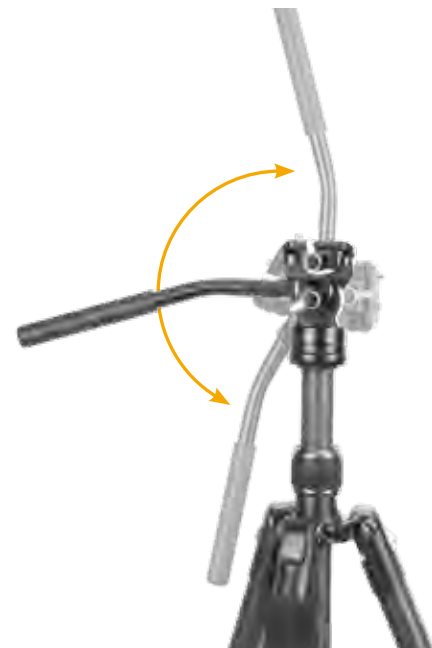

MODEL	LENGTH [INCHES / MM]	WIDTH [INCHES / MM]	HEIGHT [INCHES / MM]	HEAD BASE [INCHES / MM]	QUICK SHOE	FRONTAL TILT°	LATERAL TILT°	SWIVEL°	MAX LOAD [LBS / KG]	WEIGHT [LBS / G]
VEO PV-16	/	4.06 / 103	4.21 / 107	2.17 / 55	QS-7IP	-45°~90°	/	360°	22.0 / 10	1.51 / 686
VEO PV-14	/	3.98 / 101	3.09 / 90	1.97 / 50	QS-7IP	-45°~90°	/	360°	17.6 / 8	1.20 / 543.4
VEO PV-12	/	3.19 / 81	3.09 / 78.5	1.57 / 40	QS-55P	-75°~90°	/	360°	13.22 / 6	0.74 / 335
VEO PV-10	/	3.78 / 96	3.09 / 78.5	1.57 / 40	QS-55P	-75°~90°	/	360°	11.0 / 5	0.81 / 367



# BALL HEAD ALTA BH

Explore Your World

ALTA BH ball heads are a traditional, Arca compatible ball head with precision control. With a carrying capacity of up to 30kg/66lbs you can bet your gear on top will remain rock steady. This series has a separate locking knob, friction knob and panning knob allowing the unit to adjust to your working style.



\*Alta BH-300



\*Alta BH-250



\*Alta BH-100

# DUAL AXIS BALL HEAD VEO BH

VEO BH Arca compatible Dual Axis ball heads include a second panoramic axis on the top plate. This allows you to find a level on any terrain in seconds without needing to mess around with the tripod legs, and then reframe your shot or create perfect panoramas without needing to constantly check your level. Indoors the dual axis combination offers maximum control and precision when framing your shot. With a maximum load capacity of up to 25kg/55lbs and easy-grip locking knobs, these heads are ideal for the most discerning of photographers.



\*VEO BH-250S



\*VEO BH-160S



\*VEO BH-110S

MODEL	LENGTH [INCHES / MM]	WIDTH [INCHES / MM]	HEIGHT [INCHES / MM]	HEAD BASE [INCHES / MM]	QUICK SHOE	FRONTAL TILT°	LATERAL TILT°	SWIVEL°	MAX LOAD [LBS / KG]	WEIGHT [LBS / G]
ALTA BH-300	23.7 / 604	4.1 / 105	4.7 / 119	2.6 / 67	QS-60 V2	/	-90°~38°	360	66.1 / 30	1.34 / 646
ALTA BH-250	21.5 / 545	4.1 / 105	4.5 / 115	2.4 / 61	QS-60 V2	/	-90°~32°	360	44.1 / 20	1.27 / 565
ALTA BH-100	20.5 / 520	3.8 / 97	4.5 / 115	2.3 / 58	QS-60 V2	/	-91°~35°	360	22.0 / 10	1.0 / 472
VEO BH-250S	4.1 / 105	2.91 / 74	4.76 / 121	2.3 / 58	QS-62 V3	/	-91°~41°	360	55.1 / 25	1.42 / 643
VEO BH-160S	/	3.78 / 96	4.37 / 111	2.3 / 58	QS-62 V3	/	-91°~35°	360	33.1 / 15	1.08 / 690
VEO BH-110S	/	3.46 / 88	4.13 / 105	1.9 / 50	QS-62 V3	/	-91°~35°	360	22.0 / 10	0.94 / 427



# 3-WAY PAN HEAD VEO PH

Explore Your World

Vanguard's PH series of 3-way pan heads boasts an array of user-friendly features for easy and accurate panning, whether you're shooting photo or video (or locking in optics). The top handle rotates around in 90° segments, allowing you to select the most comfortable position for the shot – which also makes it ideal for both left- and right-handed photographers, or photographers who want to use the head with an L-bracket and a long lens.

## New



\*VEO PH-38S



\*VEO PH-36S

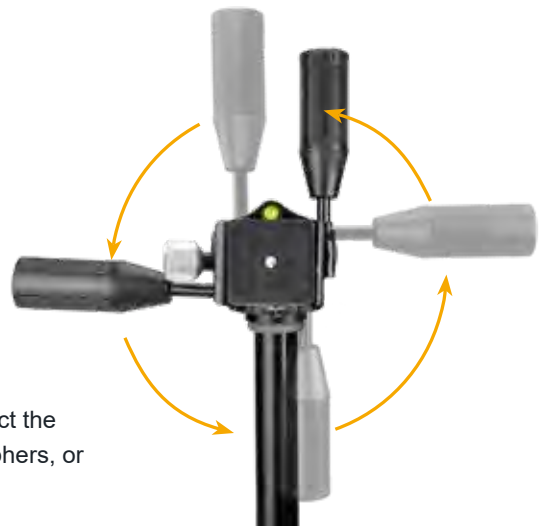

The top handle rotates round in 90° sections, allowing the photographer to select the most comfortable position for the shot, making it ideal for left-handed photographers, or photographers who want to use the head with an L-bracket and a long lens.



3 Way pan head come with extendable handle easy to operate



Textured design for a better fit and slip resistance

MODEL	LENGTH [INCHES / MM]	WIDTH [INCHES / MM]	HEIGHT [INCHES / MM]	HEAD BASE [INCHES / MM]	QUICK SHOE	FRONTAL TILT°	LATERAL TILT°	SWIVEL°	MAX LOAD [LBS / KG]	WEIGHT [LBS / G]
VEO PH-38S	8.2 / 210	7.0 / 180	4.4 / 112	2.28 / 58	QS-74	-9°~30°	/	360	22 / 10	1.42 / 644
VEO PH-36S	8.0 / 205	6.9 / 177	4.3 / 111	1.97 / 50	QS-74	-9°~30°	/	360	13.2 / 6	1.25 / 567.5





# 2 WAY PAN HEADS FOR FULL SIZED TRIPODS **VEO PH** Explore Your World

VEO PH 2-way pan heads allow one-handed control of both the pan and tilt lock, leaving your other hand free to operate controls with ease. Each pan head includes an Arca compatible quick-release plate with a spring pin that is designed for spotting scopes or long lenses, but if your spotting scope or lens has an Arca compatible foot, it can be slotted directly into the base without the use of the quick-release plate for maximum stability.

**New**



\*VEO PH-28



\*VEO PH-26



Telescopic long handle  
(Easy to fold)



Complete control through  
single handle

# 2 WAY PAN HEADS FOR TRAVEL SIZED TRIPODS **VEO PH**

The VEO PH-24 includes a similar handle to the full sized heads, but this just controls vertical tilt, with a separate locking knob that controls the pan lock. This makes it more versatile for cameras as well as sporting scopes and long lenses. The VEO PH-20 includes a traditional handle with the vertical tilt and panning controlled by separate locking knobs. This makes it more versatile for cameras as well as sporting scopes and long lenses, and the handle can be folded back making it easy to pack away.



\*VEO PH-24



\*VEO PH-20

MODEL	LENGTH [INCHES / MM]	WIDTH [INCHES / MM]	HEIGHT [INCHES / MM]	HEAD BASE [INCHES / MM]	QUICK SHOE	FRONTAL TILT°	LATERAL TILT°	SWIVEL°	MAX LOAD [LBS / KG]	WEIGHT [LBS / G]
VEO PH-28	9.06 / 230	3.94 / 100	3.27 / 83	2.28 / 58	QS-55P	/	/	360	17.6 / 8	1.39 / 631.1
VEO PH-26	6.85 / 174	3.82 / 97	2.99 / 76	1.97 / 50	QS-55P	/	/	360	13.2 / 6	1.11 / 501.6
VEO PH-24	8.27 / 210	3.74 / 95	2.91 / 74	1.65 / 42	QS-55P	-60°~90°	/	360	6.6 / 3	0.70 / 319
VEO PH-20	-	2.95 / 75	3.21 / 81.5	1.73 / 44	QS-55P	/	/	360	13.2 / 6	0.86 / 319.6

# TRIPOD ACCESSORIES VEO QS-360

Explore Your World

VEO QS-360 is designed to turn any Arca-compatible head into a dual axis head for maximum control. It's also perfect for allowing you use both a long lens and an L-bracket on an Arca compatible 3-way pan head, or turning your 2-way pan head into a 3-way pan head.



\*VEO QS-360



New "Stop System"

QS-62V3



Anti-rotation Pin

QS-76

MODEL	LENGTH [ INCHES / MM ]	WIDTH [ INCHES / MM ]	HEIGHT [ INCHES / MM ]	QUICK SHOE	MAX LOAD [ LBS / KG ]	WEIGHT [ LBS / G ]
VEO QS-360	4.1 / 105	2.2 / 55	1.6 / 40	QS-76 / QS-62V3	22 / 10	0.4 / 0.23

# TRIPOD ACCESSORIES VEO PA-10 / BT-11

## VEO PA-10 SMARTPHONE KIT

VEO PA-10 is a clamp that fits any smartphone up to 86mm/3.38 inches and attaches to any tripod head using the 1/4" thread, with a VEO BT-11 Bluetooth remote control that can be used with any IOS or Android phone



\*VEO PA-10

## VEO BT-11 BLUETOOTH REMOTE CONTROL

A Bluetooth remote to pair with your smartphone for hands-free shutter triggering. Works with iOS and Android devices. The VEO BT-11 includes CR2032 battery (always keep out of reach of children)" put bottom left below the PA-10 image as applies to both models.



\*VEO BT-11



# TRIPOD ACCESSORIES QUICK SHOES

Explore Your World

QS quick release plates make attaching and removing your camera or spotting scope a breeze, securely keeping your gear in position.

## QS-72T

- Smartphone holder
- 1/4" camera screw & pin with D-ring
- Arca compatible



## QS-74

- 1/4" camera screw with D-ring
- 4-way Arca-compatible base

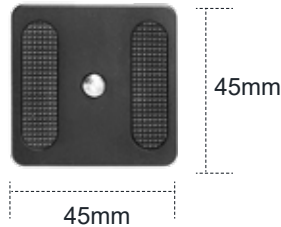

## QS-71P

- 1/4" camera screw & pin with D-ring
- 2-way Arca-compatible base

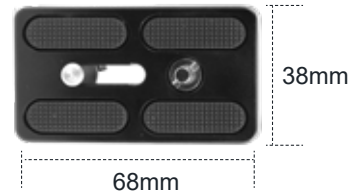

## QS-62 V3

- 1/4" camera screw with D-ring
- 2-way Arca-compatible base
- Removable safety screws

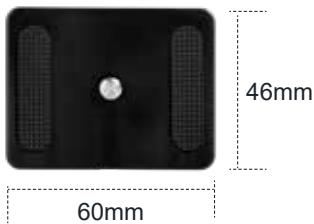

## QS-60 V2

- 1/4" camera screw with D-ring
- 2-way Arca-compatible base

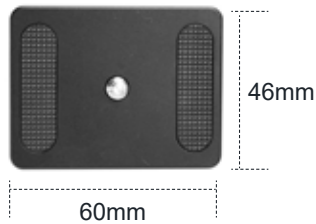

## QS-55P *New*

- 1/4" camera screw & pin with D-ring
- 2-way Arca-compatible base

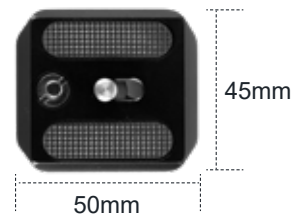

## QS-39

- 1/4" camera screw

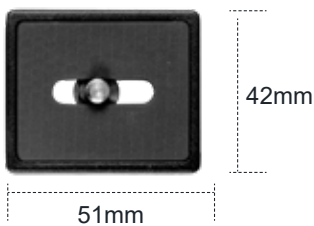

## QS-36

- 1/4" camera screw & pin with D-ring

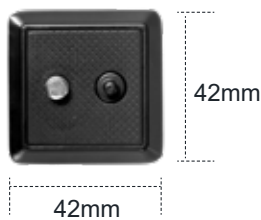

## QS-29

- 1/4" camera screw & pin with D-ring
- Lightweight plastic components

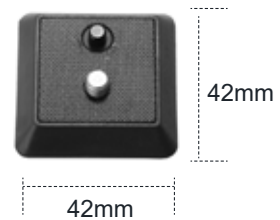

# TRIPOD ACCESSORIES VEO CP KIT / CP / SPH

Explore Your World

VEO CP Kits are designed to help you take your smartphonography to another level and include a VEO CP Clamp, a VEO TSA DLX Tripod Support Arm and VEO SPH Smartphone Holder. This allows you to attach your smartphone to almost any object around you up to 65mm wide, offering more shooting angles and enabling you to capture more wonderful moments.



\*VEO CP-46

\*VEO SPH

\*VEO TSA DLX M

\*VEO CP 46 KIT



\*VEO CP-65

\*VEO SPH

\*VEO TSA DLX L

\*VEO CP 65 KIT

## VEO SPH SMARTPHONE HOLDER

The VEO SPH Smartphone Holder is an advanced design accessory that securely holds any smartphone up to 90mm/3.5 inches wide for vertical or horizontal photography and filming. This holder includes a cold shoe mount for a microphone, wireless receiver, or other accessory.



\*VEO SPH

## VEO CP CLAMP

Attach your camera, smartphone or accessory to the surfaces around you, wherever you are, to get that perfect shot.

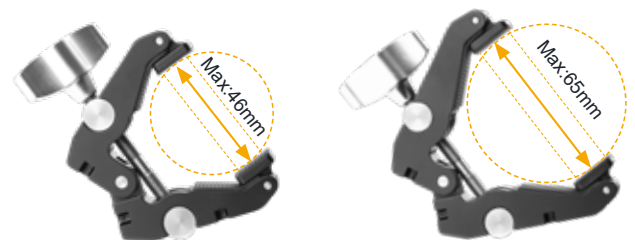

\*VEO CP-46

\*VEO CP-65

MODEL	LENGTH [INCHES / MM]	WIDTH [INCHES / MM]	HEIGHT [INCHES / MM]	MAX LOAD [LBS / KG]	WEIGHT [LBS / G]	SIZE RANGE [INCHES / MM]
VEO CP-65	3.3 / 82.5	0.8 / 20	3.5 / 89.0	5.5 / 2.5	0.4 / 159	2.6 / 65
VEO CP-46	2.7 / 68.0	0.8 / 20	3.3 / 82.5	3.3 / 1.5	0.3 / 132	1.8 / 46
VEO CSMM2	3.6 / 91.0	3.1 / 78	4.3 / 110	1.1 / 0.5	0.4 / 181	2.2-3.5 / 57-90

With the ever growing demand for flexibility, Vanguard is proud to introduce the VEO Creative Tripod Accessories Series that is designed to turn your tripod into a multi-functional tool for any photography style.

## VEO CSM COLD SHOE MOUNTS

A versatile range of cold shoe mounts that allow you to attach and aim up to three accessories (LED lights, microphones, etc.) to your camera and tripod.



\*VEO CSM



\*VEO CSM DLX



\*VEO CSMM2



\*VEO CSMM3

## VEO TSA TRIPOD SUPPORT ARMS

Attach a tripod support arm to your tripod (or VEO CSMM3) to add additional accessories



\*VEO TSA S



\*VEO TSA M



\*VEO TSA DLX M



\*VEO TSA DLX L

## VEO TC TABLET CONNECTOR

With a solid aluminum design, Arca-compatible or 1/4" thread base, easy-twist lock system, and cold shoe seat on the top, this is a versatile tablet connector that can be used on a tripod, head, support arm, or standalone. Fits tablets up to 220cm/12inches wide



\*VEO TC



MODEL	LENGTH [INCHES / MM]	WIDTH [INCHES / MM]	HEIGHT [INCHES / MM]	MAX LOAD [LBS / KG]	WEIGHT [LBS / G]
VEO CSM	/	0.9 / 24.7	1.1 / 27.9	6.6 / 3	0.06 / 25
VEO CSM DLX	/	1.2 / 31	2.2 / 57	44 / 2	0.19 / 86.5
VEO CSMM2	4.7 / 120	1.7 / 44.5	2.0 / 50.8	44 / 2	0.4 / 185
VEO CSMM3	3.4 / 87.4	0.8 / 22	1.1 / 29	44 / 2	0.19 / 86
VEO TC M	2.1 / 54	1.8 / 47	6.0 / 153	2.2 / 1	0.6 / 298

MODEL	STANDARD HT. [INCHES / MM]	FOLDED HT. [INCHES / MM]	MAX LOAD [LBS / KG]	WEIGHT [LBS / G]
VEO TSA S	4.5 / 115	2.5 / 63.5	44 / 2	0.2 / 98.5
VEO TSA M	5.9 / 152	3.0 / 76.5	44 / 2	0.2 / 106
VEO TSA DLX M	7.0 / 180	4.4 / 113	6.6 / 3	0.4 / 217
VEO TSA DLX L	11.4 / 290	6.5 / 167	6.6 / 3	0.5 / 267

# BAGS

Since 1986, Vanguard has been a part of the worldwide photo/video market and launched new products every year. We have been recognized by well-known awards all over the world, have worked with creators from all walks of life, and have sold our products in more than 80 countries.

Vanguard's large selection of camera trolley bags, backpacks, and messenger bags consists of three main families: The Alta series, which boasts advanced features geared toward professionals; the VEO series, which offers versatility, reliability, and cutting-edge designs for all types of users; and the Vesta series, our family of practical equipment designed for newcomers or those who just need a simple solution. With hundreds of different color and style choices, we are sure to have the right bag to carry your gear and configure it to your liking.



BAGS



TROLLEYS



BAG-IN-BAG



CASES



# PROFESSIONAL BACKPACKS ALTA SKY

Explore Your World

Alta Sky is a series of dynamic backpacks and daypacks with a new take on what versatility can offer a professional photographer. Vanguard's design team created a new standard in adaptable carrying and working solutions, enabling a simple transition from 100% gear to 100% personal and anywhere in between.



reddot award  
winner



\*ALTA SKY 51D



ALTA SKY 68

(Pro-DSLR and up to 800mm lens with additional lenses)

Carry up to a 16" laptop and multiple accessories

Well padded for maximum protection across the most rugged terrain

Advanced harness system to carry heavy loads in comfort



Designed to carry up to an 800mm lens with pro-body attached

MODEL	INTERIOR DIMENSIONS [INCHES / MM]	EXTERIOR DIMENSIONS [INCHES / MM]	MAX LOAD [LBS / KG]	WEIGHT [LBS / KG]	FITS DEVICE	TABLET POCKET	LITERSIZE [L]
ALTA SKY 68	13.4×7.1×22.9 / 340×180×580	14.1×9×23.4 / 360×230×595	35.3 / 16.0	6.5 / 2.9	11" TABLET / 16" LAPTOP	YES	36
ALTA SKY 66	10.2×9.4×24 / 260×240×610	11.3×11.3×24.3 / 290×290×620	23.1 / 10.5	5.5 / 2.5	11" TABLET	YES	30
ALTA SKY 62	11.4×6.5×50.1 / 290×165×510	14.1×11.3×21.5 / 360×285×545	30.86 / 14.0	5.86 / 2.66	11" TABLET / 16" LAPTOP	YES	24.4
ALTA SKY 42	9.5×5.9×18.5 / 240×150×470	10.6×10.4×19.9 / 270×265×505	26.46 / 12.0	4.14 / 1.88	12.9" TABLET	YES	16.9
ALTA SKY 53	12.6×7.8×20.8 / 320×200×530	15×10.6×22.8 / 380×270×580	35.2 / 16.0	6.2 / 2.8	17" LAPTOP	YES	34
ALTA SKY 51D	12.6×7.8×20 / 320×200×510	14.6×10.2×22.2 / 370×260×565	29.7 / 13.5	6.5 / 2.9	15" LAPTOP	YES	32
ALTA SKY 45D	10.2×7.5×17.7 / 260×190×450	12.2×9×19.5 / 310×230×495	19.8 / 9.0	4.8 / 2.2	13" LAPTOP	YES	22







# SERIES HIGHLIGHTS

Explore Your World

- Ultimate versatility: 100% gear to 100% personal and anywhere in between
- Multi-access & quick action: Full rear opening and top access | + side access in daypacks
- Carry a full-size tripod centrally for maximum comfort over extended distances
- No fumbling: Bright-colored interior makes finding things easy
- Business oriented: All bags have laptop or tablet carry ability (see chart for details)
- Alta Sky 68 can also carry up to 7 additional lenses (or personal kit)

*New*

*New*



\*ALTA SKY 66  
(Pro-DSLR and up to 800mm lens)

\*ALTA SKY 62  
(Pro-DSLR and up to 600mm lens with additional lenses)

\*ALTA SKY 42  
(Mirrorless and up to 600mm lens with additional lenses)

\*ALTA SKY 53/51D/45D



Quick Access



Optimal balance tripod carrying system



Ergonomic air system back, harness & waist belt



Keep dry - total coverage rain cover

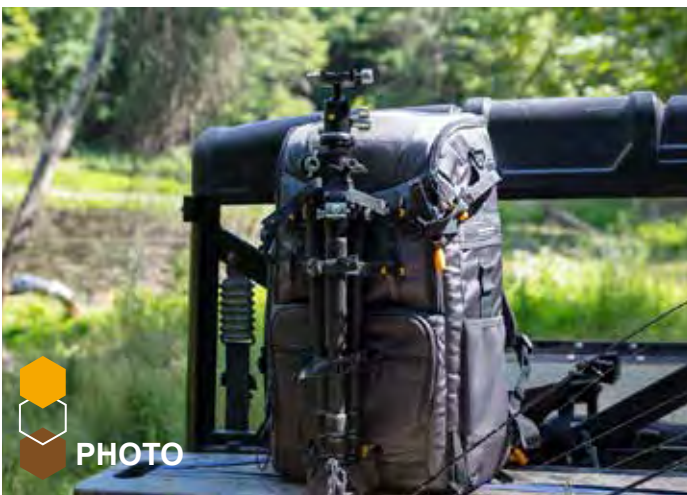

# ADVENTURE BACKPACKS VEO ACTIVE

Explore Your World

VEO ACTIVE bags are a sure fit for photographers on the go, as well as hikers, campers, birdwatchers - practically any outdoor adventurer. Dual-laminated 840D nylon ripstop materials protect your bag from the elements, as well as the wear and tear brought on by the natural world, while carrying a large load of camera bodies and lenses (or camping gear) in comfort over longer distances.

COLOR OPTIONS 



\*VEO ACTIVE 53

- External usb plug for easy and quick Charging need
- Quick water bag access design
- Light weight aluminum frame
- Independent waist system



MODEL	INTERIOR DIMENSIONS [INCHES / MM]	EXTERIOR DIMENSIONS [INCHES / MM]	MAX LOAD [LBS / KG]	WEIGHT [LBS / KG]	FITS DEVICE	TABLET POCKET	LITERSIZE [L]
VEO ACTIVE BIRDER 56	12.2×7.1×22.04 / 310×180×560	12.9×9.8×22.8 / 330×250×580	48.5 / 22	5.3 / 2.4	10" TABLET / 16" LAPTOP	YES	47
VEO ACTIVE 53	12.2×7.1×20.9 / 310×180×530	12.9×9.8×21.7 / 330×250×550	44.1 / 20	6.4 / 2.9	10" TABLET / 16" LAPTOP	YES	45
VEO ACTIVE 49	12.2×7.1×19.3 / 310×180×490	12.9×9.8×20.1 / 330×250×510	35.3 / 16	6 / 2.7	10" TABLET / 15" LAPTOP	YES	35
VEO ACTIVE 46	10.6×6.3×18.1 / 270×160×460	11.4×9.1×18.7 / 290×230×475	24.2 / 11	5.6 / 2.5	10" TABLET / 14" LAPTOP	YES	25
VEO ACTIVE 42M	9.8×5.9×17.7 / 250×150×420	10.6×7.5×17.3 / 270×190×440	18.7 / 8.5	4.3 / 1.96	10" TABLET / 13" LAPTOP	YES	17



# SERIES HIGHLIGHTS

Explore Your World

- Waterproof material with rain cover for wettest days
- Expanding pockets on shoulder strap and waist belt
- Top compartment
- Carry up to a 16" laptop
- Modular divider set
- Sealed pocket for up to a 2-litre water pouch
- Includes USB charger port to allow charging on the go
- Adjustable Waist Strap
- Keep dry - total coverage rain cover
- Trolley sleeve included



\*VEO ACTIVE Birder 56 spotting scope bag



\*VEO ACTIVE 49



\*VEO ACTIVE 46



\*VEO ACTIVE 42M



Inner Box (except VEO Active Birder 56)



Optimal balance tripod carrying system



Multi-function perfectly meets the needs of outdoor personnel



Lens pouch & accessory bag (except VEO Active Birder 56)



# ROLLING BAGS VEO SELECT

Explore Your World

Vanguard's innovative VEO SELECT trolley bag series comes in four sizes and two colors, and most are designed to be airline carry-on friendly. These are stylish and durable bags that are designed for pro-level gear and up to two tripods. All models include a sturdy double handle and come with a choice of 2 or 4 wheels. Plus, all Select bags convert to a shoulder bag or backpack to cover more ground in comfort.

COLOR OPTIONS 



\*VEO Select 55BT



\*Veo Select 42T



\*VEO SELECT 58T

Four Wheels Converts to backpack

**BUSINESS ORIENTED**  
Holds a 17" laptop + 9.7" tablet

**QUICK ACTION** Reach gear quickly using top opening

**EASE OF TRANSPORT**-'Tuck-away' advanced backpack harness plus agile four-wheel backpack



Numerous adjustable and removable dividers for maximum versatility

MODEL	INTERIOR DIMENSIONS [INCHES / MM]	EXTERIOR DIMENSIONS [INCHES / MM]	MAX LOAD [LBS / KG]	WEIGHT [LBS / KG]	FITS DEVICE	LITERSIZE [L]
VEO SELECT 59T	13×6.8×18.5 / 330×170×470	14.2×8.7×21.5 / 360×220×545	33.1 / 15	9.22 / 4.18	11" TABLET / 17" LAPTOP	26
VEO SELECT 58T	11.8×6.9×18.5 / 300×175×470	14.2×10.2×24 / 360×260×610	33.1 / 15	11.24 / 5.10	11" TABLET / 16" LAPTOP	26
VEO SELECT 55BT	12.3×6.3×17.5 / 310×160×445	14.2×8.2×22.1 / 360×220×560	27.6 / 12.5	9.52 / 4.32	11" TABLET / 15" LAPTOP	22
VEO SELECT 42T	14.6×6.3×13 / 370×160×330	16.5×9.9×17.9 / 420×250×455	26.5 / 12	8.55 / 3.88	11" TABLET / 15" LAPTOP	20

\*Excludes VEO Select 58T. Airline carry-on regulations are subject to change and vary by airline and country. To meet the requirements, you may need to remove laptops, tripod holders, and attachments. Call your airline or visit its website for current size and weight restrictions.





# SERIES HIGHLIGHTS

Explore Your World

- High quality scratch and water resistant material (with rain cover for wettest days) and sturdy double handle
- All models convert to either a shoulder bag or a backpack to cover uneven ground
- Quick access – reach gear quickly using front access (55BT/59T) or the top opening (42T)
- All models are designed to carry pro-level gear, including a tripod and up to a 17” laptop
- All bags double as luggage; simply remove the interior divider compartment
- Designed to meet IATA airline carry-on luggage guidelines (2020)\*



**\*VEO SELECT 59T**  
(Two wheels converts to backpack)



**\*VEO SELECT 55BT**  
(Two wheels converts to backpack)



**\*VEO SELECT 42T**  
(Four wheels, converts to shoulder bag)



Inner box  
(VEO Select 55BT/58T)



Quick top access  
(Veo select 42t)



Multiple carrying styles and  
movable pad to reduce  
carrying pressure



Keep dry - total coverage  
rain cover



 PHOTO





# CLASSIC BACKPACKS VEO SELECT

Explore Your World

VEO Select 45BFM and 48BF are classic backpacks that fit a camera with up to 7-8 lenses and a 15" laptop.

COLOR OPTIONS



\*VEO SELECT 48BF



\*VEO SELECT 45BFM



Numerous adjustable and removable dividers for maximum versatility

## SERIES HIGHLIGHTS

- Tripod carry-along integrated options inside and outside
- Extra strap connection up front or on the bottom
- Plenty of dividers and inserts to allow 100% gear or 100% personal items
- Incognito -no one needs to know this is a camera bag
- Safe storage - secure rear pocket for travel document and wallet
- Keep dry - total coverage rain cover

MODEL	INTERIOR DIMENSIONS [INCHES / MM]	EXTERIOR DIMENSIONS [INCHES / MM]	MAX LOAD [LBS / KG]	WEIGHT [LBS / KG]	FITS DEVICE	LITER SIZE [L]
VEO SELECT 48BF	11.8×6.5×18.9 / 300×165×480	13.3×9.6×20.5 / 335×245×520	25.5 / 11.6	4.2 / 1.9	11" TABLET / 15" LAPTOP	24
VEO SELECT 45BFM	10.6×5.1×16.9 / 270×130×430	11.8×8.3×18.3 / 300×210×465	19.1 / 8.7	3.2 / 1.4	11" TABLET	15



# SLIM BACKPACKS VEO SELECT

Explore Your World

VEO Select 37BRM and 46BR measure just 28cm wide, but they don't compromise on how much kit they can hold. With fast side access on either side, these bags are perfect for left- or right-handed photographers.

COLOR OPTIONS 



\*VEO SELECT 46BR/ 37BRM

VEO Select 45M and 49 are slim and stylish backpacks with a top section for personal kit, and they convert to a shoulder bag in seconds.

COLOR OPTIONS 



\*VEO SELECT 49



VEO SELECT 49/45M  
Backpack & shoulder bag in one

## SERIES HIGHLIGHTS

- Multi-access quick-action – full rear opening, side and top access
- Well organized - dedicated pockets for all essentials
- Always protected - well-padded all round
- Ease of transport - connects to the handle of your wheel-along luggage
- Stay steady - tripod carrying system
- Keep dry - total coverage rain cover

MODEL	INTERIOR DIMENSIONS [ INCHES / MM ]	EXTERIOR DIMENSIONS [ INCHES / MM ]	MAX LOAD [ LBS / KG ]	WEIGHT [ LBS / KG ]	FITS DEVICE	LITERSIZE [ L ]
VEO SELECT 46BR	9.9×5.9×18.1 / 250×150×460	11.0×8.3×18.7 / 280×210×475	19.8 / 9.0	3.0 / 1.3	13" LAPTOP	17
VEO SELECT 37BRM	10.0×4.5×14.6 / 255×115×370	11.0×6.9×15.4 / 280×175×390	9.3 / 4.2	2.3 / 1.0	11" TABLET	11
VEO SELECT 49	11.3×4.9×19.2 / 290×125×490	13.3×8.1×19.9 / 340×205×505	20.2 / 9.2	3.6 / 1.6	15" LAPTOP	18
VEO SELECT 45M	10.9×4.4×17.7 / 275×110×450	12.6×7.5×18.1 / 320×190×460	17.1 / 7.8	3.3 / 1.5	15" LAPTOP	14

# ROLL-TOP BACKPACKS VEO SELECT

Explore Your World

The VEO SELECT 39RBM/43RB is a stylish roll-top backpack with a full front opening to the gear compartment and a flexible wide opening top personal compartment. It is ideal for enthusiastic image makers who want to carry as much as possible in a compact, stylish fashion that does not shout, "I am a camera bag!"

COLOR  
OPTIONS



\*VEO SELECT 43RB



\*VEO SELECT 39RBM



Top compartment for personal kit

## SERIES HIGHLIGHTS

- Wide shoulder straps with honeycomb material provides best carrying experience
- Always supported- VEO tripod carry-along integrated solutions inside and outside
- Fast front access to your kit and tablet
- Numerous adjustable and removable dividers for maximum versatility
- Never tire - Convenient and comfortable harness
- Keep dry - total coverage rain cover

MODEL	INTERIOR DIMENSIONS [ INCHES / MM ]	EXTERIOR DIMENSIONS [ INCHES / MM ]	MAX LOAD [ LBS / KG ]	WEIGHT [ LBS / KG ]	FITS DEVICE	LITERSIZE [ L ]
VEO SELECT 43RB	9×4.9×16.5 / 230×125×420	12.3×8.1×18.5 / 310×205×470	16.5 / 7.5	2.7 / 1.2	11" TABLET	12
VEO SELECT 39RBM	8.3×4×15 / 210×100×380	10.7×6.8×16.9 / 270×170×430	9.3 / 4.2	2.3 / 1.0	11" TABLET	8



# SHOULDER BAGS VEO SELECT

Explore Your World

VEO Select 22S, 28S, and 36S shoulder bags are designed to carry your gear in comfort while offering fast access when you need it.

COLOR  
OPTIONS



\*VEO SELECT 36S/28S



\*VEO SELECT 22S



Front carrying(28s/36s)



Versatile



Elevation Feet

## SERIES HIGHLIGHTS

- Shoulder and handle pad: effectively reduce carrying burden
- Memorycard, accessory, and laptop/tablet pockets
- Sturdy shoulder strap with metal buckle
- Trolley sleeve for hands free travel convenience
- Quality material is strong & water/scratch resistant
- Total-coverage rain cover

MODEL	INTERIOR DIMENSIONS [ INCHES / MM ]	EXTERIOR DIMENSIONS [ INCHES / MM ]	MAX LOAD [ LBS / KG ]	WEIGHT [ LBS / KG ]	FITS DEVICE	LITERSIZE [ L ]
VEO SELECT 36S	14.6×6.9×9.0 / 370×175×230	15.8×9.9×11.4 / 400×250×290	24.2 / 11	3.7 / 1.6	13" LAPTOP	15
VEO SELECT 28S	11.0×6.5×9.0 / 280×165×230	12.8×9.0×11.0 / 325×230×280	15.4 / 7	3.0 / 1.3	11" TABLET	10
VEO SELECT 22S	9.3×4.8×7.3 / 235×120×185	10.6×6.8×9.0 / 270×170×230	6.6 / 3	1.6 / 0.7	7.9" TABLET	5

VEO CITY's sleek, modern design is now available in a handsome backpack series. Enjoy innovative storage solutions while keeping your gear well-organized and safe on the go. VEO CITY backpacks give you an all-in-one bag that exudes effortless style. Perfect for larger mirrorless and DSLR camera kits, these backpacks are designed to carry and organize everything you need for a shoot in one bag. Designed for rear access, but can also be adapted for top

COLOR  
OPTIONS



\*VEO CITY B46



\*VEO CITY B37



Includes versatile accessories pouch

## SERIES HIGHLIGHTS

- Sleek, modern design with real embossed leather finish
- Robust weatherproof material, with a rain cover for the wettest days
- Up to 23 litre capacity which holds a camera and up to 6 lenses with a 16" laptop
- Detachable accessories pouch that can fit to the front of the bag or be carried separately
- All models can carry a travel tripod, or other support such as a gimbal
- RFID-protected top pocket to keep cards and keys safe as you travel

MODEL	INTERIOR DIMENSIONS [INCHES / MM]	EXTERIOR DIMENSIONS [INCHES / MM]	MAX LOAD [LBS / KG]	WEIGHT [LBS / KG]	FITS DEVICE	LITERSIZE [L]
VEO CITY B46	11.4×6.1×18.1 / 290×155×460	12.6×9.1×18.5 / 320×230×470	28.7 / 13	5.2 / 2.4	10.9" TABLET / 15" LAPTOP	23
VEO CITY B42	10.3×5.7×16.5 / 260×145×420	12×8.9×16.9 / 305×225×430	22.1 / 10	4.4 / 2.0	8.3" TABLET / 13" LAPTOP	18
VEO CITY B37	8.6×5.5×15 / 220×140×380	10.3×8.9×15.8 / 260×225×400	15.4 / 7	3.5 / 1.6	10.9" TABLET	13





# SHOULDER BAG VEO CITY

Explore Your World

VEO CITY is already known for its model-esque looks and superior functionality, but now it is available in a stylish shoulder bag series. When you do not want to carry a ton of gear, but you still need some room in your bag, VEO CITY S bags deliver an array of configuration options while staying steady and comfortable over your shoulder.

COLOR  
OPTIONS



\*VEO CITY S36



\*VEO CITY S30



Includes versatile accessories pouch



RFID blocking inner pocket for protection



High-quality water-resistant materials, with rain cover for the wettest days

## SERIES HIGHLIGHTS

- Sleek, modern design with real embossed leather finish
- Robust weatherproof material, with a rain cover for the wettest days
- Up to 11 litre capacity which holds a camera and up to 3 lenses with a 13" laptop
- Detachable accessories pouch that can fit to the front of the bag or be carried separately
- All models can carry a travel tripod, or other support such as a gimbal
- RFID-protected top pocket to keep cards and keys safe as you travel

MODEL	INTERIOR DIMENSIONS [INCHES / MM]	EXTERIOR DIMENSIONS [INCHES / MM]	MAX LOAD [LBS / KG]	WEIGHT [LBS / KG]	FITS DEVICE	LITERSIZE [L]
VEO CITY S36	14.1 x 4.8 x 9.5 / 360 x 120 x 240	15 x 8.3 x 10 / 380 x 210 x 255	19.8 / 9	3.5 / 1.6	13" LAPTOP	11
VEO CITY S30	11.8 x 4.4 x 8.3 / 300 x 110 x 210	13.3 x 8.1 x 8.6 / 335 x 205 x 220	13.2 / 6	2.9 / 1.3	10.9" TABLET	8

# CROSS BODY BAG VEO CITY

Explore Your World

The VEO CITY Cross Body (CB) bag is designed to be an all-in-one bag that earns high grades in both function and fashion. It can organize and carry your photography kit or vlogging kit, from the camera to cables, including up to a travel tripod. The cross-body shoulder design then allows you to position the bag in the most comfortable position, whether walking or in use.

COLOR OPTIONS



\*VeO City CB29



\*VEO CITY CB 34



\*VEO CITY CB 24



\*VEO CITY CB 29



Elasticated loops that are designed to hold cables, and larger objects secure on the go



The buckle adjusts to your body for the most comfortable fit



Carry a support such as a gimbal, table tripod or travel tripod for maximum stability

## SERIES HIGHLIGHTS

- Tough internal frame and water-resistant exterior
- Removable shoulder straps
- Internal pockets made of 4-way stretch fabric
- Slot for charging/headphone cable
- Stitch free for a sleek and premium finish
- Slimline smart dividers
- Flexible storage space
- Trolley sleeve (CB34 only)

MODEL	INTERIOR DIMENSIONS [INCHES / MM]	EXTERIOR DIMENSIONS [INCHES / MM]	MAX LOAD [LBS / KG]	WEIGHT [LBS / KG]	FITS DEVICE	LITERSIZE [L]
VEO CITY CB 34	11.4-13×3.9×9.3 / 290-330×100×235	13.8×5.8×9.9 / 350×145×250	18.7 / 8.5	2.25 / 1.02	12.9" TABLET	8
VEO CITY CB 29	10.3-11.4×3.5×7.9 / 260-290×90×200	12.3×5.4×8.5 / 310×135×215	11.0 / 5	1.81 / 0.82	8.3" TABLET	6
VEO CITY CB 24	8.6-9.5×3.1×5.8 / 220-240×80×140	10.3×4.8×6.3 / 260×120×160	5.5 / 2.5	1.28 / 0.58	/	3



VEO CITY TP is a collection of useful tech pouches that can make carrying your gear a lot easier. The VEO CITY Tech Pouch (TP) is designed to be a multifunctional bag that doubles as a fashion accessory. It can organize and carry all your photography accessories or your vlogging kit, or any other kit you need on the go, from a first-aid kit to a handbag/manbag. TP models are perfect for carrying a gimbal or selfie stick, for vloggers on the go with smartphones or compact cameras.

COLOR OPTIONS 



\*VEO CITY TP 33



\*VEO CITY TP 23



\*VEO CITY TP 28



Elasticated loops that are designed to hold cables, and larger objects secure on the go



13" laptop pouch convertsto a trolley sleeve



Carry a support such as a gimbal, table tripod, or travel tripod for maximum stability

## SERIES HIGHLIGHTS

- Tough internal frame and water-resistant exterior
- Removable shoulder straps
- Internal pockets made of 4-way stretch fabric
- Carry up to a 13" laptop
- Stitch free for a sleek and premium finish
- Slimline smart dividers
- Flexible storage space
- Trolley sleeve (TP33 only)

MODEL	INTERIOR DIMENSIONS [INCHES / MM]	EXTERIOR DIMENSIONS [INCHES / MM]	MAX LOAD [LBS / KG]	WEIGHT [LBS / KG]	FITS DEVICE	LITERSIZE [L]
VEO CITY TP 33	13.4×3.8×9.9 / 340×95×250	14.1×6.5×10.6 / 360×165×270	17.6 / 8	2.60 / 1.18	12.9" TABLET / 13" LAPTOP	8
VEO CITY TP 28	11×3.4×6.8 / 280×85×170	11.8×4.8×7.6 / 300×120×195	6.6 / 3	1.54 / 0.70	8.3" TABLET	4
VEO CITY TP 23	9×3.4×5.5 / 230×85×140	9.9×4.8×6.3 / 250×120×160	4.4 / 2	1.23 / 0.56	/	2.5

# BACKPACK VEO ADAPTOR

Explore Your World

The VEO Adaptor backpacks include an external USB interface opening – so you can stay charged and connected on the go. In addition they include large access openings and increased waterproofing to keep your equipment safe yet accessible. They are comfortable with thick padded handles for easy carrying. As with all Vanguard photography bags, the Adaptor series offers numerous options for internal configurations, so you can find your optimal setup based on your rig. Carry a laptop or tablet as well as your camera and lenses, memory cards, and other accessories – adapt your bag for your needs. Enjoy more variety with the new VEO Adaptor bags, which are available in two sizes and two colors, as well as rear-opening and side-opening models – making eight total choices.

COLOR  
OPTIONS



\*VEO Adaptor R48



\*VEO Adaptor R48



\*VEO Adaptor R44



USB charger port for charging on the go

## SERIES HIGHLIGHTS

- Reflective stitching - Safer to carry in the dark
- Multiple pockets for all your accessories
- Anti-theft zipper and secure strap
- Up to 16" mac book (VEO Adaptor R48)
- Optimized to carry a tripod comfortably
- Rain cover included

MODEL	INTERIOR DIMENSIONS [ INCHES / MM ]	EXTERIOR DIMENSIONS [ INCHES / MM ]	MAX LOAD [ LBS / KG ]	WEIGHT [ LBS / KG ]	FITS DEVICE	LITERSIZE [ L ]
VEO ADAPTOR R48	10.3×6.3×18.0 / 260×160×480	11.4×8.6×19.3 / 290×220×490	25.4 / 11.5	3.22 / 1.46	16"MACBOOK	20
VEO ADAPTOR R44	8.6×6.3×16.9 / 220×160×430	10.3×8.6×17.8 / 260×220×450	19.8 / 9.0	2.78 / 1.26	13"MACBOOK	16





# SHOULDER BAGS VEO ADAPTOR

Explore Your World

The VEO Adaptor Shoulder Bag series is designed to carry and protect your camera kit with ease. The modern design applies high-quality tear-and water-resistant material with a waterproof zipper for a high level of protection on the go. Designed to carry a camera with up to 2-3 lenses (or a small drone), VEO Adaptor is packed with additional storage pockets for all the accessories you need. All this and easy to carry, with a choice of handle or shoulder strap, along with a belt sleeve to keep the bag close and secure as you travel.

COLOR  
OPTIONS



\*VEO Adaptor 24M



\*VEO Adaptor 15M



## SERIES HIGHLIGHTS

- Reflective stitching - Safer to carry in the dark
- Top waterproof zip pocket - Store paper, cards, and more
- Elastic side pockets - Store small accessories
- Up to 8" tablet (VEO Adaptor 24M)
- Waterproof and highly snag-resistant
- Rain cover included

MOD EL	INTERIOR DIMENSIONS [ INCHES / MM ]	EXTERIOR DIMENSIONS [ INCHES / MM ]	MAX LOAD [ LBS / KG ]	WEIGHT [ LBS / KG ]	FITS DEVICE	LITERSIZE [ L ]
VEO ADAPTOR 24M	8.9×4.5×6.3 / 225×115×160	9.8×5.9×9.1 / 250×150×230	25.4 / 11.5	0.97 / 0.44	8" TABLET	4.1
VEO ADAPTOR 15M	7.1×4.1×5.9 / 180×105×150	8.3×5.3×8.7 / 210×135×220	19.8 / 9.0	0.71 / 0.32	/	2.8



# BACKPACKS/SHOULDER BAGS VEO GO

Explore Your World

Having your camera with you no matter where you are is key to shooting that memorable experience. VEO GO is a dedicated mirrorless/CSC/hybrid camera bag series, classically stylish with a fresh urban traveler look that does not shout, "I am a camera bag!" All models are super-compact, yet spacious inside. And they are feature-rich, offering second-to-none gear protection alongside plenty of pockets for your important personal daily or travel needs. The backpacks can easily transform into regular daypacks.

COLOR  
OPTIONS



\*VEO GO 46/42M



\*VEO GO 21M



\*VEO GO 24M/15M



Backpacks are rear-opening

## SERIES HIGHLIGHTS

- Easy & secure access-shoulder bags open away from the body for quick & easy access. Backpacks offer full rear opening for added security in crowds.
- Off the clock, easily transforms into an everyday backpack or shoulder bag
- Intuitive straightforward setup for camera gear and personal effects
- Snug and protective - perfectly sized to fit mirrorless/CSC/hybrid camera models

MODEL	INTERIOR DIMENSIONS [INCHES / MM]	EXTERIOR DIMENSIONS [INCHES / MM]	MAX LOAD [LBS / KG]	WEIGHT [LBS / KG]	FITS DEVICE	LITERSIZE [L]
VEO GO 46M	10.4×4.1×18.1 / 265×105×460	11.4×5.5×18.5 / 290×140×470	15.9 / 7.2	2.20 / 1.00	13" LAPTOP	13
VEO GO 42M	9.6×3.8×16.5 / 245×95×420	10.3×5.1×16.9 / 260×130×430	8.8 / 4.0	1.98 / 0.90	11" TABLET	9.8
VEO GO 24M	8.8×4.1×6.2 / 225×105×160	9.5×4.8×7.1 / 240×125×180	6.6 / 3.0	0.75 / 0.34	/	3.8
VEO GO 21M	8.3×4.1×7.5 / 210×105×190	10.6×5.8×8.3 / 270×145×210	6.2 / 2.8	0.93 / 0.42	7.9" TABLE	4.2
VEO GO 15M	7.1×4.1×6.2 / 180×105×160	7.6×4.8×7.1 / 195×125×180	3.3 / 1.5	0.68 / 0.31	/	3.0





# SHOULDER BAGS VEO RANGE

Explore Your World

Choosing between your daily bag and your camera bag can be quite a tough decision. Whether you are staying close to home or venturing out, with VEO RANGE shoulder bags, this need no longer be of concern. The amazing functional versatility of these bags allows you to safeguard a variety of photo or video gear alongside your personal effects. Due to the casual design of this series, by simply removing the gear, inserts or dividers, you have a great stylish and spacious everyday carrying solution.

COLOR  
OPTIONS



\*VEO RANGE 38



\*VEO RANGE 21M



\*VEO RANGE 32M



## SERIES HIGHLIGHTS

- VEO Range 38 includes double-deck design, with lower section for a travel tripod up to 42cm or additional camera gear
- Set-up versatility- with plenty of dividers and inserts to allow 100% gear or 100% personal, depending on the user
- Incognito - no one need know this is a camera bag
- Keep dry - total-coverage rain cover

MODEL	INTERIOR DIMENSIONS [INCHES / MM]	EXTERIOR DIMENSIONS [INCHES / MM]	MAX LOAD [LBS / KG]	WEIGHT [LBS / KG]	FITS DEVICE	LITERSIZE [L]
VEO RANGE 38	15.1×5.7×11.7 / 385×145×300	16.8×8.2×13.3 / 430×210×340	15.9 / 7.2	2.64 / 1.20	15" LAPTOP	17
VEO RANGE 32M	12.6×5.3×9.1 / 320×135×230	14.2×6.5×9.8 / 360×165×250	12.1 / 5.5	1.85 / 0.84	12.9" TABLET	10
VEO RANGE 21M	9.2×4.4×7.5 / 235×110×190	10.6×6.3×8.6 / 270×160×220	6.2 / 2.8	1.06 / 0.48	7.9" TABLET	5

# BACKPACKS VESTA ASPIRE

Explore Your World

The VESTA Aspire 41 is the ideal compact, lightweight, and stylish daypack for a DSLR or CSC (Compact System Camera) with medium lens attached, 4-5 additional lenses, flash, accessories, a travel tripod, and personal essentials such as wallet, phone, and water bottle.

COLOR  
OPTIONS



\*VESTA ASPIRE 41



Carry a tripod in side pocket

## BACKPACK HIGHLIGHTS

- Secured back opening keep equipment protected
- 9.7" tablet compartment
- Extra-protective sewing for better security
- Lightweight and easy to carry
- Comfortable padded carrying strap
- Smooth and durable zipper

MODEL	INTERIOR DIMENSIONS [INCHES / MM]	EXTERIOR DIMENSIONS [INCHES / MM]	MAX LOAD [LBS / KG]	WEIGHT [LBS / KG]	FITS DEVICE	LITERSIZE [L]
VESTA ASPIRE 41	8.9×5.9×16.1 / 225×150×410	10×8.7×18.3 / 255×220×465	11.0   5	1.70 / 0.77	9.7" TABLET	14





# SHOULDER BAGS VESTA ASPIRE

Explore Your World

The Vesta Aspire Collection by Vanguard has set its goal to become the 'go-to' accessory choice of new photographers engaging for the first time in the world of image making. Our collection goals were simple: Our accessories must share the passion, while offering a seamless and intuitive user experience that will become part of everyday life alongside the key star – the new camera! In this new series, we guarantee the perfect first bag for anyone starting to engage passionately in photography. Designed for the most popular camera kits.

COLOR OPTIONS



\*VESTA ASPIRE 12



\*VESTA ASPIRE 15Z/16Z



\*VESTA ASPIRE 15



\*VESTA ASPIRE 21/25



\*VESTA ASPIRE 30/33

## SHOULDER BAG HIGHLIGHTS

- Quick top access, numerous dividers, dedicated pockets
- Front pocket for personal items or accessories
- Comfortable padded carrying strap
- Smooth and durable zipper

MODEL	INTERIOR DIMENSIONS [ INCHES / MM ]	EXTERIOR DIMENSIONS [ INCHES / MM ]	MAX LOAD [ LBS / KG ]	WEIGHT [ LBS / KG ]	FITS DEVICE	LITERSIZE [ L ]
VESTA ASPIRE 33	13×54×9.3 / 330×135×235	15×7.5×10.4 / 380×190×265	14.3 / 6.5	1.7 / 0.76	12.9" TABLET	10.5
VESTA ASPIRE 30	11.8×6.8×8.3 / 300×170×210	14.1×8.5×9.9 / 360×215×250	13.2 / 6	1.5 / 0.68	11" TABLET	10.7
VESTA ASPIRE 25	10.2×6.7×8.3 / 260×170×210	11.4×8.1×10 / 290×205×255	9.9 / 4.5	1.06 / 0.48	9" TABLET	9.3
VESTA ASPIRE 21	8.7×5.3×7.7 / 220×135×195	9.8×6.5×8.7 / 250×165×220	5.1 / 2.3	0.73 / 0.33	/	5.8
VESTA ASPIRE 16Z	6.1×4.9×8.3 / 155×125×210	7.9×6.8×13 / 200×170×330	4.1 / 2.5	0.71 / 0.32	/	5.3
VESTA ASPIRE 15	6.3×4.5×5.9 / 160×115×150	7.0×5.9×7.9 / 180×150×200	3.3 / 1.5	0.48 / 0.22	/	2.8
VESTA ASPIRE 15Z	5.9×4.9×7.9 / 150×125×200	6.9×5.7×9.4 / 175×145×240	4.9 / 2.2	0.51 / 0.23	/	3.8
VESTA ASPIRE 12	6.3×3.8×4.4 / 160×95×110	8.1×4.8×6.1 / 205×120×155	2.2 / 1.0	0.4 / 0.18	/	1.6

# BAG-IN-BAG VEO BIB F

Explore Your World

The VEO BIB F Series is designed to fit inside the backpack or roller case of your choice, allowing you to carry your camera gear inside a larger bag. With a choice of front access or top access in every model, these are ideal partners for the backpack or roller bag of your choice. Alternatively, they can be carried separately using the comfortable handle or shoulder strap. Inside the slim, smart dividers can be tailored for your gear, and this doesn't need to be just for cameras and lenses. In addition, there are multiple storage pockets for all the accessories you need including up to an 11" tablet.



\*VEO BIB F36



\*VEO BIB F33

\*VEO BIB F28

\*VEO BIB F27



## SERIES HIGHLIGHTS

- Next-gen "smart" dividers let you truly customize the bag's interior to better fit your camera bodies, lenses, and more
- Durable water-resistant material helps keep your gear safe for the long haul
- Front access to full kit, with quick top access
- Trolley sleeve (except F27)

MODEL	INTERIOR DIMENSIONS [INCHES / MM]	EXTERIOR DIMENSIONS [INCHES / MM]	MAX LOAD [LBS / KG]	WEIGHT [LBS / KG]	FITS DEVICE	LITERSIZE [L]
VEO BIB F36	11.0×6.3×15.0 / 280×160×380	12.6×7.7×16.1 / 320×195×410	16.5 / 7.5	2.29 / 1.0	11" TABLET	17
VEO BIB F33	11.0×6.3×11.0 / 280×160×280	12.4×7.7×12.4 / 315×195×315	13.2 / 6	1.90 / 0.86	11" TABLET	13
VEO BIB F28	11.0×6.3×7.1 / 280×160×180	12.4×7.7×9.3 / 315×195×235	9.9 / 4.5	1.50 / 0.68	7" TABLET	8
VEO BIB F27	8.3×4.3×11.0 / 210×110×280	9.4×5.7×12.4 / 240×145×315	8.4 / 3.8	1.19 / 0.54	7" TABLET	6.5





# BAG-IN-BAG VEO BIB T

Explore Your World

The VEO BIB T Series is a top-access camera bag for smaller camera kits (up to 3 lenses), that is designed to fit into the bag of your choice. By design, it is ideally suited for a shoulder bag, but it can also be used to keep your camera safe between locations in any style of bag (such as in your everyday hand luggage) and then used on location as a lightweight shoulder bag when you reach your destination.



\*VEO BIB T25



\*VEO BIB T22



\*VEO BIB T18



## SERIES HIGHLIGHTS

- Next-gen “smart” dividers let you truly customize the bag’s interior to better fit your camera bodies, lenses, and more
- Padded handle and shoulder strap
- Multiple pockets for accessories
- Trolley sleeve (T25 only)
- Water-resistant material

MODEL	INTERIOR DIMENSIONS [INCHES / MM]	EXTERIOR DIMENSIONS [INCHES / MM]	MAX LOAD [LBS / KG]	WEIGHT [LBS / KG]	FITS DEVICE	LITERSIZE [L]
VEO BIB T25	9.8×4.3×7.5 / 250×110×190	10.8×5.5×8.3 / 275×140×210	7.1 / 3.2	1.15 / 0.52	/	5.2
VEO BIB T22	8.7×3.9×6.3 / 220×100×160	9.8×5.1×7.3 / 250×130×185	6.2 / 2.8	0.88 / 0.40	/	3.5
VEO BIB T18	7.1×3.9×5.5 / 180×100×140	8.3×5.1×6.7 / 210×130×170	4.4 / 2.0	0.71 / 0.32	/	2.5

# TOUGH BAG-IN-BAG VEO BIB DIVIDER S

Explore Your World

The tough, water-resistant outer shell on all the VEO BIB DIVIDER S Series is designed to keep valuable gear safe at home or on the go, while being easy to carry with a comfortable handle or padded shoulder strap. Alternatively, it can be used with a SUPREME hard case for the ultimate protection. Inside, the slim smart dividers can be tailored for your gear, and this doesn't need to be just for cameras and lenses. In addition, there are multiple storage pockets for all the accessories you need, including up to a 15" laptop.



Photo/Video Equipment



Bird Watching Equipment



Precision Instruments



\*VEO BIB DIVIDER S53



\*VEO BIB DIVIDER S37



\*VEO BIB DIVIDER S40



\*VEO BIB DIVIDER S46



\*VEO BIB DIVIDER S53

## SERIES HIGHLIGHTS

- EVA moulded construction 1000D polyester and metal frame for maximum protection
- Separate storage tray for a wealth of accessories such as SD cards and cables
- Pockets in the lid for up to a 15" laptop and documents
- Padded handle and padded shoulder strap for carrying
- Suitable for a pro DSLR/mirrorless camera and up to 18 lenses
- Secure, waterproof zip closure

MODEL	INTERIOR DIMENSIONS [INCHES / MM]	EXTERIOR DIMENSIONS [INCHES / MM]	MAX LOAD [LBS / KG]	WEIGHT [LBS / KG]	FITS DEVICE	LITERSIZE [L]
VEO BIB DIVIDER S53	21.1×6.9×15.7 / 535×175×400	22.0×8.7×17.1 / 560×220×435	29.8 / 13.5	6.70 / 3.04	15" LAPTOP	38
VEO BIB DIVIDER S46	17.5×6.9×12.8 / 445×175×325	18.9×8.5×14.0 / 480×215×355	24.2 / 11.0	5.33 / 2.42	13" LAPTOP	26
VEO BIB DIVIDER S40	15.6×5.9×9.6 / 395×150×245	17.1×7.5×10.8 / 435×190×275	19.2 / 8.7	3.92 / 1.78	11" TABLET	15
VEO BIB DIVIDER S37	13.6×5.9×8.1 / 345×150×205	15.4×7.5×9.8 / 390×190×250	13.7 / 6.2	3.13 / 1.42	7" TABLET	11





# HOME STORAGE DIVIDER BAG

Explore Your World

Vanguard Divider Bags are designed to fit inside Supreme Cases and offer ideal set-up for photo and video gear within the security of an infallible hard case.



Photo/Video Equipment



Bird Watching Equipment



Precision Instruments



\*DIVIDER BAG 53



\*Compatible with Supreme case series(sold separately)



\*Divider Bag 53



\*Divider Bag 46



\*Divider Bag 40



\*Divider Bag 37

## SERIES HIGHLIGHTS

- Padded storage bag to keep your gear safe in a Supreme Case, or safe at home when not needed
- Thick, soft padding provides cushioned protection for gear
- Padded handle for carrying
- Removable and adjustable dividers
- Zippered pockets for accessories

MODEL	INTERIOR DIMENSIONS [ INCHES / MM ]	EXTERIOR DIMENSIONS [ INCHES / MM ]	MAX LOAD [ LBS / KG ]	WEIGHT [ LBS / KG ]	FITS DEVICE	LITERSIZE [ L ]
DIVIDER BAG 53	21×15.8×6.9 / 535×400×175	22×16.8×7.9 / 560×425×200	/	3.64 / 1.65	/	38
DIVIDER BAG 46	17.5×12.9×6.9 / 445×325×175	18.8×13.7×7.6 / 480×345×195	/	3.00 / 1.34	/	26
DIVIDER BAG 40	15.5×9.6×5.9 / 395×245×150	17×10.9×6.8 / 430×275×170	/	1.98 / 0.90	/	15
DIVIDER BAG 37	13.7×8.1×5.9 / 345×205×150	15×9.8×6.8 / 380×240×170	/	1.65 / 0.75	/	11

# WATERPROOF CASE SUPREME

Explore Your World

Virtually indestructible, rugged Vanguard Supreme Series hard cases have innovative features for unmatched strength and durability. They are O-ring sealed, waterproof (up to a depth of 16.5 feet/5 meters), airtight, and built to withstand the most extreme conditions. Supreme cases are great for airline travel with an automatic pressure equalization valve. Anti-slip rubber feet and a solid carrying handle offer extra durability. Rest assured, your camera gear is safe from all harm in these cases.



\*SUPREME 53F



\*SUPREME 53D



INCREDIBLY STRONG & RUGGED



WATER & DUST PROOF

## SERIES HIGHLIGHTS

- Waterproof and airtight (up to a depth of 16.5 feet/5 meters)
- High-density customizable, hexagon-shaped foam interior
- Steel-reinforced lock holders
- Two storage levels

MODEL	INTERIOR DIMENSIONS [INCHES / MM]	EXTERIOR DIMENSIONS [INCHES / MM]	MAX LOAD [LBS / KG]	WEIGHT [LBS / KG]	FITS DEVICE	LITER SIZE [L]
SUPREME 53F/53D	22×17.7×7.8 / 560×450×200	24.8×20.4×9.4 / 630×520×240	/	23 / 10.4	/	/
SUPREME 46F/46D	18.9×14.5×7.8 / 480×370×200	20.2×17.1×8.6 / 515×435×220	/	15 / 6.8	/	/
SUPREME 40F/40D	16.9×11.6×6.8 / 430×295×175	18.3×14.3×7.6 / 465×365×195	/	9.7 / 4.4	/	/
SUPREME 37F/37D	16.3×10.2×6.8 / 380×260×175	16.3×9.2×7.6 / 415×325×195	/	8.6 / 3.9	/	/
SUPREME 27F/27D	11×9.8×6.6 / 250×190×150	11×9.8×6.6 / 280×250×170	/	4.19 / 1.9	/	/

\*Liter size is space in case and camera space will be smaller





Our photographers deserve the ultimate Alta Experience and a seamless workflow wherever their passion leads them. We offer them great products to enhance and support their passion not just when carrying their gear, but also when shooting in the field. Alta Accessories are part of a wider range of Alta tripods and bags and together, they enable Vanguard to offer solutions for specific requirements such as quick action, element protection, gear organization, ergonomic comfort, and much more.

## ALTA ACTION TRIPOD BAG

The Alta Action advanced carrying tripod bags are tailored to best fit and protect our Alta Pro tripods & heads. More than just a great tripod carrying solution, these bags are designed to support the full Alta experience.



MODEL	INTERIOR DIMENSIONS [INCHES / MM]	EXTERIOR DIMENSIONS [INCHES / MM]	MAX LOAD [LBS / KG]	WEIGHT [LBS / KG]
ALTA ACTION 80	31.5×6.7×5.1 / 800×170×130	32.1×7.1×5.5 / 815×180×140	8.8 / 4.0	0.84 / 0.38
ALTA ACTION 70	27.5×6.7×5.1 / 700×170×130	28.1×7.1×5.5 / 715×180×140	7.7 / 3.5	0.77 / 0.35
ALTA ACTION 60	23.6×5.5×3.8 / 600×140×100	24.2×5.8×4.3 / 615×150×110	6.6 / 3	0.66 / 0.30

## ALTA SBM/SBL STONE BAG

• Stabilize any tripod by providing a centralized, balanced weight

### Stone Bag Medium

Exterior dimension:  
355×350mm / 14x13.7in  
Expanding strap: 180mm / 7.2in  
Max leg-to-leg distance:  
680mm / 26.7in  
Max loading: 20kg / 44lbs  
Max leg diameter: <40mm



### Stone Bag Large

Exterior dimension:  
355×350mm / 14x13.7in  
Expanding strap: 220mm / 8.6in  
Max leg-to-leg distance:  
760mm / 30in  
Max loading: 30kg / 66lbs  
Max leg diameter: <45 mm



Metal Weight Hook

## ALTA BCS/BCL BATTERY CASE

### Battery Case Small

Outside Dimensions:  
105×35×115mm / 4.1×1.3×4.5in  
Weight:  
0.09 lbs / 0.04kg



### Battery Case Large

Outside Dimensions:  
105×35×115mm / 4.1×1.3×4.5in  
Weight:  
0.09 lbs / 0.04 kg





# RAIN COVER ALTA RGS/M/L/XL

Explore Your World

The Alta Rain Cover is an ingenious, shooting-in-the-rain solution designed to protect your camera and lens from the elements. This multi-use cover folds into a compact pouch and easily fits in any bag, so that you are never caught out in a downpour without adequate protection.



## Rain Cover Small

Outside Dimensions:  
510×600mm / 20.1×23.6in  
Weight: 0.19lbs / 0.08kg  
Camera lens:  
24-70mm/18/135mm F2.8



## Rain Cover Medium

Outside Dimensions:  
600×600mm / 23.6×23.6in  
Weight: 0.19lbs / 0.08kg  
Camera lens: 70-200mm



## Rain Cover Large

Outside Dimensions:  
860×950mm / 34×37.3in  
Weight: 0.29lbs / 0.12kg  
Camera lens: ~400mm



## Rain Cover Extra large

Outside Dimensions:  
970×950mm / 38.3×37.3in  
Weight: 0.29lbs / 0.12kg  
Camera lens: ~600mm



## VEO LPC OUTDOORS MICRO FIBRE LENS CLOTH

### Perfect for cleaning

Outside Dimensions:  
75×75 mm / 3×3 in  
Weight:  
0.44 lbs | 0.2 kg





# OPTICS

Since 1986, VANGUARD has been a part of the worldwide photo/video market and launched new products every year. We have been recognized by well-known awards all over the world, have worked with creators from all walks of life, and have sold our products in more than 80 countries.

Vanguard optics belong to one of three main families: The Endeavor series, which boasts advanced features geared toward professionals; the VEO series, which offers advanced features for all types of users; and the Vesta series, our family of practical equipment designed for newcomers or those who just need a simple solution. Our collections include a wide range of binoculars, monoculars, spotting scopes, mounts, and other accessories.



SPOTTING SCOPES



BINOCULARS



MONOCULARS

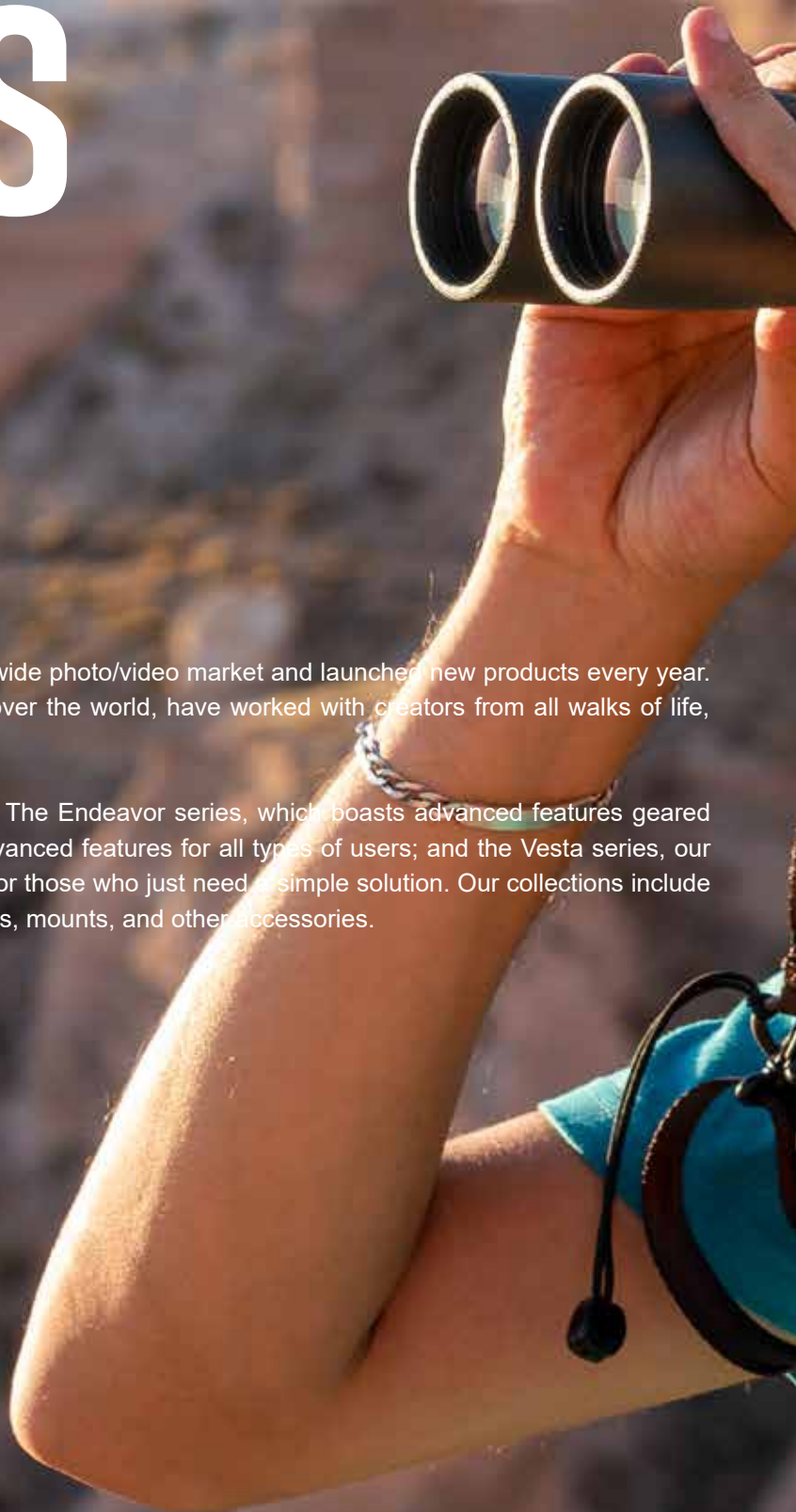



# SPOTTING SCOPES VEO HD IV

Explore Your World

The VEO HD IV spotting scope delivers top-notch optical quality for your adventures in the great outdoors. Extra-low dispersion HOYA ED glass ensures accurate color rendition and virtually eliminates color fringing. The lenses are fully multicoated to ensure optimal light transmission and feature a phasecoated BAK4 roof prism. It also provides a very impressive field of view. This scope is equipped with a large, smooth-focusing wheel for quick adjustments. It is nitrogen-filled, making it waterproof/fogproof for challenging weather conditions. The lightweight and durable carbon-composite body is well-balanced for easy use while out in nature.



MODEL	POWER [X]	OBJECTIVE LENS [MM]	FIELD OF VIEW [FT/1000 YDS   M/1000 M]	NEAR FOCUS [FEET   M]	EYE RELIEF [MM]	WEIGHT [LBS   G]
VEO HD IV 82A	20-60	82	104.4~57   34.8~18.7	19.7~21.3   6~6.5	18~22	4.32   1960
VEO HD IV 65A	18.75-45	65	125.7~68   41.9~22.7	19.7~21.3   6~6.5	18~21	3.43   1560



# SERIES HIGHLIGHTS

Explore Your World

- Premium HOYA ED glass provides a true color viewing experience
- Large 58mm eyepiece with generous eye relief
- Arca compatible foot to fit into suitable clamp and eliminate movement
- Fully Multi-Coated with Multiguard® 7
- Dual-focus controls include fine tuning adjustments
- Waterproof, and nitrogen filled to be fogproof

25~60  
X

18.7~45  
X



\*VEO HD IV 82A



Includes fitted cover with shoulder strap



Removable eyepiece



Built-in sunshield eliminates glare in direct sunlight



Find the most comfortable viewing angle with 180° rotatable front body

# SPOTTING SCOPES VEO HD

Explore Your World

Enjoy nature from afar wherever you go with the brilliantly engineered Vanguard HD spotting scope. Vanguard has continued to pursue the highest standards with our advanced manufacturing technology, enhancing this scope with carbon-composite housing. Stronger and lighter than aluminum, the composite material can effectively reduce vibration and improve the long-term stability of your optics. Additionally, the VEO HD's innovative multicoated lenses help increase light transmission and make images clearer and brighter.

25~60  
X

15~45  
X



\*VEO HD 80A



## SERIES HIGHLIGHTS

- Premium ED glass assures exceptional detail and brilliant colors
- Built in sunshield to eliminate glare in direct sunlight
- Waterproof, and nitrogen filled to be fogproof
- BaK4 roof prism
- Includes carrying case with shoulder strap for easy transport afield
- Arca-compatible foot to fit into suitable clamp and eliminate movement
- Fully multi-coated with multiguard® 4
- Premium Mitsubishi rubber armor
- Large 53mm eyepiece
- Weighs as little as 1205g/2.7 lbs.

MODEL	POWER [X]	OBJECTIVE LENS [MM]	FIELD OF VIEW [FT/1000 YDS   M/1000 M]	NEAR FOCUS [FEET   M]	EYE RELIEF [MM]	WEIGHT [LBS   G]
VEO HD 80A	20~60	80	110~52   37~17	19.7~21.3   6~6.5	19~20	3.41   1550
VEO HD 60A	15~45	60	141~68   47~23	19.7~21.3   6~6.5	19~20	2.65   1205



# SPOTTING SCOPES VESTA

Explore Your World

Vesta series spotting scopes are made for anyone who is new to using optics, or experienced users who are looking for something small and easy to carry afield. As a bonus, Vesta scopes are compatible with many sizes and styles of tripod heads for mounting. Vesta 350 and 460 models are small enough to fit in the side pocket of a backpack and work great on a tabletop or bench. In short, Vesta scopes are loaded with quality at a price that delivers an excellent value.



\*VESTA 560A



**VESTA 560A**  
with VS-82 Tabletop Tripod



**VESTA 460A**  
with Vesta TT1 Tabletop Tripod



**VESTA 350A**  
with Vesta TT1 Tabletop Tripod



## SERIES HIGHLIGHTS

- Quick-focus adjustment wheel dials in finetuned details
- BAK4 prism with Multiguard® multicoated optics
- Waterproof, and nitrogen filled to be fogproof
- Modern ergonomics and contours
- Rubber armored magnesium body
- Weighs as little as 600g/1.32 lbs

MODEL	POWER [X]	OBJECTIVE LENS [MM]	FIELD OF VIEW [FT/1000 YDS   M/1000 M]	NEAR FOCUS [FEET   M]	EYE RELIEF [MM]	WEIGHT [LBS   G]
VESTA 560A	15-45	60	1044~62.6   34.8~20.9	26.3~29.5   8~9	16~21	2.85   1293
VESTA 460A	15-50	60	125.3~574   41.7~19.1	32.8~394   10~12	11	1.34   609
VESTA 350A	15~45	50	156.6~52.2   52.2~174	29.5~394   9~12	11	1.32   600

# BINOCULARS VEO HD IV

Explore Your World

Vanguard's HD IV binoculars offer all of the features that you'd expect from a high-priced set -- but without the 4-figure price tag. These binoculars incorporate HOYA extra-low dispersion (ED) glass and phase-corrected SK-15 prisms, which work together to virtually eliminate chromatic aberration and produce images with true color fidelity across the entire field of view.



\*VEO HD IV 1042



## SERIES HIGHLIGHTS

- HOYA extra low (ED) dispersion glass
- Fully Multi-Coated with Multiguard® 7
- Waterproof, and nitrogen filled to be fogproof
- Advanced multi-layer coating provides more than 92% light transmission
- SK-15 roof prism
- Lockable diopter
- Durable magnesium-alloy housing
- Tripod mountable (with adaptor such as the BA-185)

MODEL	POWER [X]	OBJECTIVE LENS [MM]	FIELD OF VIEW [FT/1000 YDS   M/1000 M]	NEAR FOCUS [FEET   M]	EYE RELIEF [MM]	ADJUST. PUPILLARY [MM]	WEIGHT [LBS   G]
VEO HD IV 1042	10	42	340   114	5.9   1.8	19	56-74	1.71   776
VEO HD IV 8420	8	42	377   126	5.9   1.8	19	56-74	1.70   775

# BINOCULARS VEO HD 2

Explore Your World

VEO HD2 binoculars features HOYA extra-low dispersion (ED) glass and phase-corrected BAK4 prisms that work together to virtually eliminate chromatic aberration and produce images with true color fidelity across the entire field of view. Complementing the glass and prisms are an anti-reflective and fully multi-coated optical system that improves light transmission for bright and clear images with greater low-light performance.



\*VEO HD2 1042



## SERIES HIGHLIGHTS

- HOYA extra low (ED) dispersion glass
- Fully Multi-Coated with Multiguard® 7
- Waterproof, and nitrogen filled to be fogproof
- Premium Mitsubishi rubber armour
- Phase corrected Bak4 roof prisms
- Lockable diopter
- Lightweight carbon composite housing
- Tripod mountable (with adaptor such as the BA-185)

MODEL	POWER [X]	OBJECTIVE LENS [MM]	FIELD OF VIEW [FT/1000 YDS   M/1000 M]	NEAR FOCUS [FEET   M]	EYE RELIEF [MM]	ADJUST. PUPILLARY [MM]	WEIGHT [LBS   G]
VEO HD 2 1042	10	42	340   114	6.5   2	18	58-74	1.58   720
VEO HD 2 8420	8	42	374   124	6.5   2	19	58-74	1.58   720

# BINOCULARS VEO HD

Explore Your World

VEO HD binoculars offer clear, vivid images thanks to extra-low-dispersion (ED) glass, which cuts out chromatic aberration and enhances color resolution and contrast. Vanguard's anti-reflective and fully multi-coated optical system improves light transmission for bright and clear images. A large, ergonomic center focus knob makes VEO HD binoculars easy to adjust. Plus, the three-stage twist-up eye cups ensure you can set the eye relief for viewing with or without eyeglasses. VEO HD bodies are made from lightweight, durable composite carbon.



10X  
8X

\*VEO HD 1042



## SERIES HIGHLIGHTS

- Extra low (ED) dispersion glass
- Fully Multi-Coated with Multiguard® 7
- Waterproof, and nitrogen filled to be fogproof
- Premium Mitsubishi moulded rubber armour
- Phase corrected Bak4 roof prisms
- Lockable dioptr
- Lightweight carbon composite housing
- Tripod mountable (with adaptor such as the BA-185)

MODEL	POWER [X]	OBJECTIVE LENS [MM]	FIELD OF VIEW [FT/1000 YDS   M/1000 M]	NEAR FOCUS [FEET   M]	EYE RELIEF [MM]	ADJUST. PUPILLARY [MM]	WEIGHT [LBS   G]
VEO HD 1042	10	42	342   114	6.6   2	18	58-74	1.69   767
VEO HD 8420	8	42	372   124	6.6   2	19	58-74	1.67   760

# BINOCULARS VEO ED

Explore Your World

VEO ED is a well-balanced, lightweight, and durable carbon-composite binocular. It is 100% waterproof/fogproof and designed to take on challenging weather conditions. Extra-low dispersion (ED) glass effectively reduces chromatic aberration and enhances color resolution and contrast. In short, VEO ED delivers true quality at a competitive price.



\*VEO ED 1050



## SERIES HIGHLIGHTS

- Extra low (ED) dispersion glass
- Fully Multi-Coated with Multiguard® 4
- Waterproof, and nitrogen filled to be fogproof
- Premium Mitsubishi textured rubber armour
- Phase corrected Bak4 roof prisms
- 3-stage twist eyecups
- Lightweight carbon composite housing
- Tripod mountable (with adaptor such as the BA-185)

MODEL	POWER [X]	OBJECTIVE LENS [MM]	FIELD OF VIEW [FT/1000 YDS   M/1000 M]	NEAR FOCUS [FEET   M]	EYE RELIEF [MM]	ADJUST. PUPILLARY [MM]	WEIGHT [LBS   G]
VEO ED 1250	12	50	251   84	11.5   3.5	18	60-75	1.67   760
VEO ED 1050	10	50	282   94	9.8   3	19	59.5-75	1.72   782
VEO ED 1042	10	42	314   105	9.2   2.8	16	55-75	1.41   640
VEO ED 8420	8	42	330   110	8.2   2.5	19	55-75	1.41   640

# BINOCULARS VEO XF

Explore Your World

Vanguard's VEO XF binoculars bring maximum value to the popular VEO optics series. These quality binoculars offer an array of features and are light to carry, balanced for comfort, and still tough enough to take what nature dishes out during your adventures. Fully multicoated lenses and industry standard BAK4 prism mean that you're getting excellent binoculars at an excellent price.



\*VEO XF 1042



## SERIES HIGHLIGHTS

- Premium optical glass
- Fully Multi-Coated with Multiguard® 4
- Waterproof, and nitrogen filled to be fogproof
- Premium Mitsubishi moulded rubber armour
- Phase corrected Bak4 roof prisms
- 3-stage twist eyecups
- Lightweight carbon composite housing
- Tripod mountable (with adaptor such as the BA-185)

MODEL	POWER [X]	OBJECTIVE LENS [MM]	FIELD OF VIEW [FT/1000 YDS   M/1000 M]	NEAR FOCUS [FEET   M]	EYE RELIEF [MM]	ADJUST. PUPILLARY [MM]	WEIGHT [LBS   G]
VEO XF 1042	10	42	332   III	6.9   2.1	16	57-74	1.41   640
VEO XF 8420	8	42	418   I33	6.9   2.1	20	57-74	1.45   660

# BINOCULARS VESTA

Explore Your World

Vesta binoculars are designed for any traveler who is looking for value without compromising on performance. Vesta binoculars contain quality glass with a BAK4 roof prism design and multicoated optics for crisp resolution, clarity, color fidelity and light transmission. Each binocular is manufactured and assembled with a lightweight yet durable housing and is waterproof and fogproof. The large center focus knob allows the user to experience everything in fine-tuned detail. From the packaging to the product and accessories, these binoculars deliver a quality design and performance and, most importantly, success afield.



10X

8X

\*VESTA 8420



## SERIES HIGHLIGHTS

- Perfect starter binoculars
- Fully multi-coated
- Lightweight yet durable rubber armor housing
- Waterproof, and nitrogen filled to be fogproof
- Phase corrected Bak4 roof prisms (BK7 in 8x25 and 10x25)
- Ergonomic and durable body
- Large center focus knob for fast and smooth ease of use
- Tripod mountable (with adaptor such as the BA-185)

MODEL	POWER [X]	OBJECTIVE LENS [MM]	FIELD OF VIEW [FT/1000 YDS   M/1000 M]	NEAR FOCUS [FEET   M]	EYE RELIEF [MM]	ADJUST. PUPILLARY [MM]	WEIGHT [LBS   G]
VESTA 1042	10	42	298   100	6.9   2.1	17	56-74	1.30   590
VESTA 8420	8	42	325   108	6.9   2.1	19	56-74	1.34   610
VESTA 1025	10	25	330   110	8.2   2.5	10	56-74	0.61   280
VESTA 8250	8	25	340   114	8.2   2.5	12.5	56-74	0.61   280



# COMPACT BINOCULARS VESTA

Explore Your World

The Vesta Compact 21 caters to nature lovers worldwide who are looking for a fun and care free optic with excellent value. The Vesta Compact 21 is a sharp looking and stylish carry along that is light in weight and high in performance. Assembled with lightweight materials, containing optical quality glass and coatings for surprising clarity and color fidelity.



10X

8X

\*VESTA 1021

## SERIES HIGHLIGHTS

- Ergonomic and durable body with a slim, sleek profile
- Includes neck strap and pouch
- Twist out and lockable rubber eyecups for comfortable viewing
- Lightweight yet durable aluminum housing
- Fast and smooth center focus wheel for ease of use
- Roof prism design and coated lenses for a clear viewing experience

MODEL	POWER [X]	OBJECTIVE LENS [MM]	FIELD OF VIEW [FT/1000 YDS   M/1000 M]	NEAR FOCUS [FEET   M]	EYE RELIEF [MM]	ADJUST. PUPILLARY [MM]	WEIGHT [LBS   G]
VESTA 1021	10	42	100.9   302.7	4   13.2	8	56.5-72	0.42   195
VESTA 8210	8	42	123.5   370.6	4   13.2	10	56.5-72	0.42   195



# MONOCULAR VEO HD2 1042M

Explore Your World

The VEO HD2 Monocular features HOYA extra-low dispersion (ED) glass to virtually eliminate chromatic aberration and produce images with true color fidelity and enhanced contrast. The package includes a smartphone digiscoping adapter and Bluetooth remote so you can capture crisp, clear images on the go.



\*VEO HD 2 1042M

## WHAT'S INCLUDED

- ① Soft Bag
- ② Neckband
- ③ Smartphone Adapter for up to 6.3 Inches
- ④ Bluetooth Remote Control for IOS/Android



## SERIES HIGHLIGHTS

- HOYA extra low (ED) dispersion glass
- Fully Multi-Coated with Multiguard® 7
- Waterproof, and nitrogen filled to be fogproof
- Objective lens cover
- Includes smartphone digiscope adaptor
- Phase corrected Bak4 roof prisms
- Ergonomic central focus wheel
- Tripod mountable using 1/4" thread on base
- Weighs just 325g and small enough to fit into a pocket
- Includes Bluetooth remote control for IOS and Android

MODEL	POWER [X]	OBJECTIVE LENS [MM]	FIELD OF VIEW [ FT/1000 YDS   M/1000 M ]	NEAR FOCUS [ FEET   M ]	EYE RELIEF [ MM ]	WEIGHT [ LBS   G ]
VEO HD 2 1042M	10	42	342   114	6.5   2.1	18	0.71   325

# MONOCULAR VEO ED 8420M

Explore Your World

Vanguard's new VEO ED 8420M monocular offers a new, compact way for you to get a closer look in the field or at events. This 100% waterproof and fogproof optics piece features extra-low dispersion (ED) glass, which effectively reduces chromatic aberration and enhances color resolution and contrast. The package includes the VEO PA-62 smartphone adapter and a Bluetooth remote so you can capture your magnified subjects in photos or videos.



\*VEO ED 8420M

## WHAT'S INCLUDED

- ① Soft Bag
- ② Neckband
- ③ Smartphone Adapter for up to 6.3 Inches
- ④ Bluetooth Remote Control for IOS/Android



## SERIES HIGHLIGHTS

- Extra low (ED) dispersion glass
- Fully multi-coated with Multiguard® 4
- Waterproof, and nitrogen filled to be fogproof
- Objective lens cover
- Includes smartphone digiscope adaptor
- Phase corrected Bak4 roof prisms
- Ergonomic central focus wheel
- Tripod mountable using 1/4" thread on base
- Weighs just 300g and small enough to fit into a pocket
- Includes Bluetooth remote control for IOS and Android

MODEL	POWER [X]	OBJECTIVE LENS [MM]	FIELD OF VIEW [ FT/1000 YDS   M/1000 M ]	NEAR FOCUS [ FEET   M ]	EYE RELIEF [ MM ]	WEIGHT [ LBS   G ]
VEO ED 8420M	10	42	324   108	8.2   2.5	19	0.66   300

# MONOCULAR VESTA 8320M

Explore Your World

The Vanguard Vesta 8320M monocular delivers optimal optical performance in a lightweight and compact body. The package includes a smartphone adapter for digiscoping and Bluetooth remote so you can capture crisp, clear images on the go.



\*VESTA 8320M

## WHAT'S INCLUDED

- ① Soft Bag
- ② Neckband
- ③ Smartphone Adapter for up to 6.3 Inches
- ④ Bluetooth Remote Control for IOS/Android



## SERIES HIGHLIGHTS

- Phase corrected BaK4 roof prism
- Ergonomic central focus wheel
- Waterproof, and nitrogen filled to be fogproof
- Objective lens cover
- Includes smartphone digiscope adaptor
- Fully multi-coated
- Waterproof, and nitrogen filled to be fogproof
- Tripod mountable using 1/4" thread on base
- Weighs just 250g and small enough to fit into a pocket
- Includes Bluetooth remote control for IOS and Android

MODEL	POWER [X]	OBJECTIVE LENS [MM]	FIELD OF VIEW [ FT/1000 YDS   M/1000 M ]	NEAR FOCUS [ FEET   M ]	EYE RELIEF [ MM ]	WEIGHT [ LBS   G ]
VESTA 8320M	10	32	392   131	6.5   2	17.7	0.55   250



## VEO PA-65

### UNIVERSAL SMARTPHONE ADAPTOR FOR MOST SPOTTING SCOPES

VEOPA-65 is a universal smartphone digiscoping kit that will fit any smartphone up to 3.54 inches/90mm wide, and can be used with almost any spotting scope from any brand to enable you to take captivating closeup shots and share them straight to social media



## VEO PA-62

### UNIVERSAL SMARTPHONE ADAPTOR FOR MOST BINOCULARS

VEO PA-62 universal digiscope adapter can be used for taking photos or video with almost any smartphone up to 91mm/3.6 inches wide, with an adjustable arm that can be aligned to any lens on the camera. It quickly attaches to the eyepiece of any binocular or monocular that has a diameter between 41.5-44.7mm/1.6-1.8 inches wide, and can be paired to Apple or Android smartphones with the included Bluetooth remote for touch-free control.



## VEO BA-185 ARCA BINOCULAR TRIPOD ADAPTOR

The VEO BA-185 ARCA binocular tripod adapter fits onto any tripod quick-release plate or directly into the clamp of an Arca-compatible tripod head. This adapter helps to steady your binoculars for clear, relaxed, hands-free viewing. It works with any roof prism binocular that has a standard 1/4" thread tripod socket, and on most models, its thin bridge allows you to set your binocular to the minimum interpupillary distance.



## VEO BA-185 BINOCULAR TRIPOD ADAPTOR

The VEO BA-185 binocular tripod adapter fits onto any tripod quick-release plate to steady your binoculars for clear, relaxed, hands-free viewing. It works with any roof prism binocular that has a standard 1/4" thread tripod socket, and on most models, its thin bridge allows you to set your binocular to the minimum interpupillary distance.

## PA-202 SPOTTING SCOPE CAMERA ADAPTOR

PA-202 is a digiscoping adaptor designed specifically to fit Endeavor HD Spotting Scopes and allow any camera with a 52/58mm lens to be attached securely





# QUICK RELEASE HARNESS SYSTEM VEO OPTIC GUARD

Explore Your World

The VEO OPTIC GUARD series is the quintessential harness solution for passionate nature lovers who use their binoculars or cameras for extended periods. The Optic Guard is designed with ultimate ergonomic comfort in mind, enabling you carry your gear in the field without added weight or pressure. Whether you're just heading out for a short hike or committed to a long-term outdoor adventure, the VEO OPTIC GUARD series is sure to enhance your overall experience.

## VEO OPTIC GUARD H DLX

COLOR OPTIONS

Strap Width : 1.0 In / 25 mm  
Max loading: 5.5 lbs / 2.5 kg  
Weight : 0.53 lbs / 240 g



## VEO OPTIC GUARD H

COLOR OPTIONS

Strap Width : 1.0 In / 25 mm  
Max loading: 2.2 lbs / 1 kg  
Weight : 0.31 lbs / 140 g



## VEO OPTIC GUARD NS

COLOR OPTIONS

Strap Width : 1.0 In / 25 mm  
Max loading: 5.5 lbs / 2.5 kg  
Weight : 0.26 lbs / 120 g  
Strap length: 33-43In / 838-1092mm



## VEO OPTIC GUARD WS

COLOR OPTIONS

Strap Width : 1.0 In / 25 mm  
Max loading: 4.0 lbs / 1.8 kg  
Weight : 0.09 lbs / 40 g



## TRIPODS SPECS

MODEL	LEG MATERIAL	FOLDED HT. [INCHES / MM]	EXTENDED HT. [INCHES / MM]	MINIMUM HT. [INCHES / MM]	LEG DIAM. [MM]	LEG SECT.	HEAD	QUICK SHOE	MAX LOAD [LBS / KG]	WEIGHT [LBS / G]
ALTA PRO 3VRL 304AT	ALUMINUM	23.86 / 606	62.99 / 1600	8.66 / 220	30	4	/	/	55.1 / 25	5.36 / 2430
ALTA PRO 3VRL 303AT	ALUMINUM	29.88 / 759	66.93 / 1700	7.09 / 180	30	3	/	/	55.1 / 25	5.38 / 2440
ALTA PRO 3VRL 304CT	CARBON FIBER	23.86 / 606	62.99 / 1600	8.66 / 220	30	4	/	/	55.1 / 25	4.58 / 2080
ALTA PRO 3VRL 303CT	CARBON FIBER	29.88 / 759	66.93 / 1700	7.09 / 180	30	3	/	/	55.1 / 25	4.60 / 2085
ALTA PRO 3VL 304AT	ALUMINUM	21.97 / 558	60.04 / 1525	5.59 / 142	30	4	/	/	28.65 / 13	3.77 / 1710
ALTA PRO 3VL 264AVI6	ALUMINUM	25.47 / 647	62.8 / 1582	9.61 / 244	26	4	VEO PV-16	QS-71P	22.04 / 10	4.42 / 2006
ALTA PRO 3VL 264AVI4	ALUMINUM	24.8 / 630	6.61 / 1565	8.94 / 227	26	4	VEO PV-14	QS-71P	17.63 / 8	4.11 / 1864
ALTA PRO 3VL 264AT	ALUMINUM	21.26 / 540	58.07 / 1475	5.39 / 137	26	4	/	/	22.04 / 10	2.91 / 1320
ALTA PRO 3VL 304CT	CARBON FIBER	21.97 / 558	60.04 / 1525	5.59 / 142	30	4	/	/	28.65 / 13	3.15 / 1430
ALTA PRO 3VL 264CVI6	CARBON FIBER	25.47 / 647	62.8 / 1582	9.61 / 244	26	4	VEO PV-16	QS-71P	22.04 / 10	3.80 / 1726
ALTA PRO 3VL 264CVI4	CARBON FIBER	24.8 / 630	6.61 / 1565	8.94 / 227	26	4	VEO PV-14	QS-71P	17.63 / 8	3.49 / 1584
ALTA PRO 3VL 264CT	CARBON FIBER	21.26 / 540	58.07 / 1475	5.39 / 137	26	4	/	/	22.04 / 10	2.29 / 1040
ALTA PRO 3VLT 235AVI2	ALUMINUM	21.22 / 539	58.23 / 1479	7.56 / 192	23	5	VEO PV-12	QS-55P	13.22 / 6	2.72 / 1235
ALTA PRO 3VLT 235AVI0	ALUMINUM	21.22 / 539	58.23 / 1479	7.56 / 192	23	5	VEO PV-10	QS-55P	11.02 / 5	2.80 / 1269
ALTA PRO 3VLT 235CVI2	CARBON FIBER	21.22 / 539	58.23 / 1479	7.56 / 192	23	5	VEO PV-12	QS-55P	13.22 / 6	2.55 / 1155
ALTA PRO 3VLT 235CVI0	CARBON FIBER	21.22 / 539	58.23 / 1479	7.56 / 192	23	5	VEO PV-10	QS-55P	11.02 / 5	2.62 / 1189

MODEL	LEG MATERIAL	FOLDED HT. [INCHES / MM]	EXTENDED HT. [INCHES / MM]	STANDARD HT. [INCHES / MM]	LEG DIAM. [MM]	LEG SECT.	HEAD	QUICK SHOE	MAX LOAD [LBS / KG]	WEIGHT [LBS / G]
VEO 5 264AVI6	ALUMINUM	23.07 / 602	66.81 / 1697	56.38 / 1432	26	4	VEO PV-16	QS-71P	22.04 / 10	4.95 / 2246
VEO 5 264AVI4	ALUMINUM	22.64 / 575	66.14 / 1680	55.71 / 1415	26	4	VEO PV-14	QS-71P	17.6 / 8	4.64 / 2103
VEO 5 264CVI6	CARBON FIBER	23.07 / 602	66.81 / 1697	56.38 / 1432	26	4	VEO PV-16	QS-71P	22.04 / 10	4.33 / 1966
VEO 5 264CVI4	CARBON FIBER	22.64 / 575	66.14 / 1680	55.71 / 1415	26	4	VEO PV-14	QS-71P	17.6 / 8	4.02 / 1823
VESTA GO 264AVI2	ALUMINUM	18.31 / 465	64.53 / 1639	52.44 / 1332	26	4	VEO PV-12	QS-55P	13.22 / 6	3.71 / 1685
VESTA GO 234AVI0	ALUMINUM	17.13 / 435	59.41 / 1509	48.50 / 1232	23	4	VEO PV-10	QS-55P	11.02 / 5	3.45 / 1567
VESTA GO 264CVI2	CARBON FIBER	18.31 / 465	64.53 / 1639	52.44 / 1332	26	4	VEO PV-12	QS-55P	13.22 / 6	3.01 / 1365
VESTA GO 234CVI0	CARBON FIBER	17.13 / 435	59.41 / 1509	48.50 / 1232	23	4	VEO PV-10	QS-55P	11.02 / 5	3.12 / 1417
VEO 3+ 303ABS	ALUMINUM	31.14 / 791	69.84 / 1774	59.57 / 1513	30	3	VEO BH-250S	QS-62V3	55.1 / 25	6.47 / 2935
VEO 3+ 303AT	ALUMINUM	26.38 / 670	65.08 / 1653	54.80 / 1392	30	3	/	/	55.1 / 25	5.05 / 2292
VEO 3+ 263ABI60S	ALUMINUM	30.47 / 774	68.46 / 1739	58.43 / 1484	26	3	VEO BH-160S	QS-62V3	33.1 / 15	5.50 / 2497
VEO 3+ 263APS	ALUMINUM	30.71 / 780	68.31 / 1735	58.27 / 1480	26	3	VEO PH-38S	QS-74	22.0 / 10	5.96 / 2705
VEO 3+ 303CBS	CARBON FIBER	31.14 / 791	69.84 / 1774	59.57 / 1513	30	3	VEO BH-250S	QS-62V3	55.1 / 25	5.70 / 2588
VEO 3+ 303CT	CARBON FIBER	26.38 / 670	65.08 / 1653	54.80 / 1392	30	3	/	/	55.1 / 25	4.29 / 1945
VEO 3+ 263CBI60S	CARBON FIBER	30.47 / 774	68.46 / 1739	58.43 / 1484	26	3	VEO BH-160S	QS-62V3	33.1 / 15	4.79 / 2172
VEO 3+ 263CPS	CARBON FIBER	30.71 / 780	68.31 / 1735	58.27 / 1480	26	3	VEO PH-38S	QS-74	22.0 / 10	5.12 / 2322
VEO 3T+ 234AB	ALUMINUM	18.11 / 460	57.48 / 1460	48.23 / 1225	23	4	VEO BH-110S	QS-62V3	22.0 / 10	6.47 / 2190
VEO 3T+ 234CB	CARBON FIBER	18.11 / 460	57.48 / 1460	48.23 / 1225	23	4	VEO BH-110S	QS-62V3	22.0 / 10	5.70 / 1978
VEO 5 304AB250S	ALUMINUM	25.16 / 639	70.31 / 1786	60.08 / 1526	30	4	VEO BH-250S	QS-62V3	44.08 / 20	5.45 / 2473
VEO 5 304AT	ALUMINUM	20.39 / 518	65.55 / 1665	55.31 / 1405	30	4	/	/	44.08 / 20	4.03 / 1830
VEO 5 264ABI60S	ALUMINUM	23.86 / 606	66.97 / 1701	56.73 / 1441	26	4	VEO BH-160S	QS-62V3	33.06 / 15	4.52 / 2050
VEO 5 234ABI10S	ALUMINUM	22.64 / 575	63.78 / 1620	53.54 / 1360	23	4	VEO BH-110S	QS-62V3	22.04 / 10	3.67 / 1667

## TRIPODS SPECS

MODEL	LEG MATERIAL	FOLDED HT. [INCHES / MM]	EXTENDED HT. [INCHES / MM]	STANDARD HT. [INCHES / MM]	LEG DIAM. [MM]	LEG SECT.	HEAD	QUICK SHOE	MAX LOAD [LBS / KG]	WEIGHT [LBS / G]
VEO 5 264APS38	ALUMINUM	23.90 / 607	67.01 / 1702	56.77 / 1442	26	4	VEO PH-38S	QS-74	22.04 / 10	4.86 / 2204
VEO 5 234APS36	ALUMINUM	22.87 / 581	64.02 / 1626	53.78 / 1366	23	4	VEO PH-36S	QS-74	12.22 / 6	3.98 / 1808
VEO 5 304CB250S	CARBON FIBER	25.16 / 639	70.31 / 1786	60.08 / 1526	30	4	VEO BH-250S	QS-62V3	44.08 / 20	4.75 / 2153
VEO 5 304CT	CARBON FIBER	20.39 / 518	65.55 / 1665	55.31 / 1405	30	4	/	/	44.08 / 20	3.33 / 1510
VEO 5 264CBI60S	CARBON FIBER	23.86 / 606	66.97 / 1701	56.73 / 1441	26	4	VEO BH-160S	QS-62V3	33.06 / 15	3.90 / 1770
VEO 5 234CBI10S	CARBON FIBER	22.64 / 575	63.78 / 1620	53.54 / 1360	23	4	VEO BH-110S	QS-62V3	22.04 / 10	1587 / 3.50
VEO 5 264CPS38	CARBON FIBER	23.90 / 607	67.01 / 1702	56.77 / 1442	26	4	VEO PH-38S	QS-74	22.04 / 10	4.24 / 1924
VEO 5 234CPS36	CARBON FIBER	22.87 / 581	64.02 / 1626	53.78 / 1366	23	4	VEO PH-36S	QS-74	12.22 / 6	3.81 / 1728
VESTA GO 264AB	ALUMINUM	17.32 / 440	63.58 / 1615	53.74 / 1365	26	4	VEO BH-60	QS-74	22.04 / 10	3.89 / 1767
VESTA GO 234AB	ALUMINUM	15.94 / 405	58.82 / 1494	49.06 / 1246	23	4	VEO BH-50	QS-74	9.9 / 4.5	2.87 / 1300
VESTA GO 204AB	ALUMINUM	15.16 / 385	54.53 / 1385	44.72 / 1136	20	4	VEO BH-45	QS-74	6.6 / 3	2.87 / 1130
VESTA GO 264CB	CARBON FIBER	17.32 / 440	63.58 / 1615	53.74 / 1365	26	4	VEO BH-60	QS-74	22.04 / 10	3.19 / 1447
VESTA GO 234CB	CARBON FIBER	15.94 / 405	58.82 / 1494	49.06 / 1246	23	4	VEO BH-50	QS-74	9.9 / 4.5	2.53 / 1150
VESTA GO 204CB	CARBON FIBER	15.16 / 385	54.53 / 1385	44.72 / 1136	20	4	VEO BH-45	QS-74	6.6 / 3	2.05 / 930
VESTA GO 264AP	ALUMINUM	18.70 / 475	65.51 / 1664	52.24 / 1327	26	4	VEO PH-24	QS-55P	6.6 / 3	3.78 / 1715
VESTA GO 234AP	ALUMINUM	17.52 / 445	60.59 / 1539	48.31 / 1227	23	4	VEO PH-24	QS-55P	6.6 / 3	3.23 / 1465
VESTA GO 204AP	ALUMINUM	16.14 / 410	55.28 / 1404	44.29 / 1125	20	4	VEO PH-24	QS-55P	6.6 / 3	2.85 / 1295
VESTA GO 264CP	CARBON FIBER	18.70 / 475	65.51 / 1664	52.24 / 1327	26	4	VEO PH-24	QS-55P	6.6 / 3	3.07 / 1395
VESTA GO 234CP	CARBON FIBER	17.52 / 445	60.59 / 1539	48.31 / 1227	23	4	VEO PH-24	QS-55P	6.6 / 3	2.90 / 1315
VESTA GO 204CP	CARBON FIBER	16.14 / 410	55.28 / 1404	44.29 / 1125	20	4	VEO PH-24	QS-55P	6.6 / 3	2.41 / 1095
VESTA GOT 233AP	ALUMINUM	10.24 / 260	22.72 / 577	18.19 / 462	23	3	VEO PH-24	QS-55P	6.6 / 3	2.54 / 1153
VESTA GOT 233CP	CARBON FIBER	10.24 / 260	22.72 / 577	18.19 / 462	23	3	VEO PH-24	QS-55P	6.6 / 3	2.45 / 1112
VESTA GOT 203AB	ALUMINUM	9.49 / 241	21.06 / 535	17.1 / 434	20	3	VEO BH-45	QS-74	6.6 / 3	1.94 / 882
VESTA TTI	ALUMINUM	6.89 / 175	3.94 / 100	/	/	1	BALL HEAD	/	44 / 2	0.34 / 156
VS-82	ALUMINUM	9.05 / 230	9.84 / 250	/	/	2	PAN HEAD	/	5.5 / 2.5	0.85 / 390
VESTA 233AP	ALUMINUM	22.9 / 582	61.0 / 1550	48.1 / 1221	23	3	PH-23	QS-29	7.7 / 3.5	2.8 / 1275
VESTA 203AP	ALUMINUM	22.5 / 570	61.0 / 1550	48.0 / 1220	20	3	PH-23	QS-29	7.7 / 3.5	2.4 / 1105
VESTA 203AGH	ALUMINUM	22.5 / 570	61.0 / 1550	48.5 / 1231	20	3	GH-45	QS-29	7.7 / 3.5	3.0 / 1360
VEO2S AM-234TBP50T	ALUMINUM	23.7 / 604	65.1 / 1654	/	23	4	VEO BP-50T	QS-72T	13.2 / 6	2.8 / 1275
VEO2S AM-264TR	ALUMINUM	21.5 / 545	64.1 / 1630	/	26	4	/	/	33.1 / 15	1.96 / 890
VEO2S AM-234TR	ALUMINUM	20.5 / 520	61.0 / 1550	/	23	4	/	/	22 / 10	1.77 / 805
VEO2S CM-264TBPI20T	CARBON FIBER	24.5 / 624	68.0 / 1729	/	26	4	VEO BP-120T	QS-72T	26.5 / 12	2.97 / 1347
VEO2S CM-264TR	CARBON FIBER	21.5 / 545	64.1 / 1630	/	26	4	/	/	33.1 / 15	1.75 / 796

MODEL	LENGTH [INCHES / MM]	WIDTH [INCHES / MM]	BASE [INCHES / MM]	WEIGHT [LBS / G]
ALTA PRO 3VRL PLATFORM 30	3.11 / 79	0.94 / 24	-	0.19 / 876
ALTA PRO 3VRL LVL 30	8.54 / 217	4.06 / 103	2.95 / 75	0.93 / 420
ALTA PRO 3VRL CC 30	15.31 / 389	3.11 / 79	2.28 / 58	0.82 / 370

## HEADS SPECS

MODEL	LENGTH [INCHES / MM]	WIDTH [INCHES / MM]	HEIGHT [INCHES / MM]	HEAD BASE [INCHES / MM]	QUICK SHOE	FRONTAL TILT°	LATERAL TILT°	SWIVEL°	MAX LOAD [LBS / KG]	WEIGHT [LBS / G]
VEO PV-16	/	4.06 / 103	4.21 / 107	2.17 / 55	QS-71P	-45°~90°	/	360°	22.0 / 10	1.51 / 686
VEO PV-14	/	3.98 / 101	3.09 / 90	1.97 / 50	QS-71P	-45°~90°	/	360°	17.6 / 8	1.20 / 543.4
VEO PV-12	/	3.19 / 81	3.09 / 78.5	1.57 / 40	QS-55P	-75°~90°	/	360°	13.22 / 6	0.74 / 335
VEO PV-10	/	3.78 / 96	3.09 / 78.5	1.57 / 40	QS-55P	-75°~90°	/	360°	11.0 / 5	0.81 / 367
ALTA BH-300	23.7 / 604	4.1 / 105	4.7 / 119	2.6 / 67	QS-60 V2	/	-90°~38°	360	66.1 / 30	1.34 / 646
ALTA BH-250	21.5 / 545	4.1 / 105	4.5 / 115	2.4 / 61	QS-60 V2	/	-90°~32°	360	44.1 / 20	1.27 / 565
ALTA BH-100	20.5 / 520	3.8 / 97	4.5 / 115	2.3 / 58	QS-60 V2	/	-91°~35°	360	22.0 / 10	1.0 / 472
VEO BH-250S	4.1 / 105	2.91 / 74	4.76 / 121	2.3 / 58	QS-62 V3	/	-91°~41°	360	55.1 / 25	1.42 / 643
VEO BH-160S	/	3.78 / 96	4.37 / 111	2.3 / 58	QS-62 V3	/	-91°~35°	360	33.1 / 15	1.08 / 690
VEO BH-110S	/	3.46 / 88	4.13 / 105	1.9 / 50	QS-62 V3	/	-91°~35°	360	22.0 / 10	0.94 / 427
VEO PH-38S	8.2 / 210	7.0 / 180	4.4 / 112	2.28 / 58	QS-74	-91°~30°	/	360	22 / 10	1.42 / 644
VEO PH-36S	8.0 / 205	6.9 / 177	4.3 / 111	1.97 / 50	QS-74	-91°~30°	/	360	13.2 / 6	1.25 / 567.5
VEO PH-28	9.06 / 230	3.94 / 100	3.27 / 83	2.28 / 58	QS-55P	/	/	360	17.6 / 8	1.39 / 631.1
VEO PH-26	6.85 / 174	3.82 / 97	2.99 / 76	1.97 / 50	QS-55P	/	/	360	13.2 / 6	1.11 / 501.6
VEO PH-24	8.27 / 210	3.74 / 95	2.91 / 74	1.65 / 42	QS-55P	-60°~90°	/	360	6.6 / 3	0.70 / 319
VEO PH-20	/	2.95 / 75	3.21 / 81.5	1.73 / 44	QS-55P	/	/	360	13.2 / 6	0.86 / 319.6
VEO QS-360	4.1 / 105	2.2 / 55	1.6 / 40	/	QS-76 QS-62V3	/	/	/	22 / 10	0.4 / 0.23

## TRIPOD ACCESSORIES SPECS

MODEL	FULL EXTENDED HT. [INCHES / MM]	CENTER COLUMN PLATE DIAMETER [INCHES / MM]	MAX LOAD [LBS / KG]	WEIGHT [LBS / G]	MODEL	LENGTH [INCHES / MM]	WIDTH [INCHES / MM]	HEIGHT [INCHES / MM]	WEIGHT [LBS / G]
VEO MT-12	25.6 / 650	2.28 / 58	22.0 / 10.00	2.2 / 1.0	VEO+MAI	2.3 / 58	3.3 / 83	2.7 / 68	0.46 / 0.21

MODEL	LENGTH [INCHES / MM]	WIDTH [INCHES / MM]	HEIGHT [INCHES / MM]	MAX LOAD [LBS / KG]	WEIGHT [LBS / G]	SIZE RANGE [INCHES / MM]
VEO CP-65	3.3 / 82.5	0.8 / 20	3.5 / 89.0	5.5 / 2.5	0.4 / 159	2.6 / 65
VEO CP-46	2.7 / 68.0	0.8 / 20	3.3 / 82.5	3.3 / 1.5	0.3 / 132	1.8 / 46
VEO CSMM2	3.6 / 91.0	3.1 / 78	4.3 / 110	1.1 / 0.5	0.4 / 181	2.2-3.5 / 57-90

MODEL	LENGTH [INCHES / MM]	WIDTH [INCHES / MM]	HEIGHT [INCHES / MM]	MAX LOAD [LBS / KG]	WEIGHT [LBS / G]
VEO CSM	/	0.9 / 24.7	1.1 / 27.9	6.6 / 3	0.06 / 25
VEO CSM DLX	/	1.2 / 31	2.2 / 57	4.4 / 2	0.19 / 86.5
VEO CSMM2	4.7 / 120	1.7 / 44.5	2.0 / 50.8	4.4 / 2	0.4 / 185
VEO CSMM3	3.4 / 87.4	0.8 / 22	1.1 / 29	4.4 / 2	0.19 / 86
VEO TC M	2.1 / 54	1.8 / 47	6.0 / 153	2.2 / 1	0.6 / 298

MODEL	STANDARD HT. [INCHES / MM]	FOLDED HT. [INCHES / MM]	MAX LOAD [LBS / KG]	WEIGHT [LBS / G]
VEO TSA S	4.5 / 115	2.5 / 63.5	4.4 / 2	0.2 / 98.5
VEO TSA M	5.9 / 152	3.0 / 76.5	4.4 / 2	0.2 / 106
VEO TSA DLX M	7.0 / 180	4.4 / 113	6.6 / 3	0.4 / 217
VEO TSA DLX L	11.4 / 290	6.5 / 167	6.6 / 3	0.5 / 267



## BAGS SPECS

MODEL	INTERIOR DIMENSIONS [INCHES / MM]	EXTERIOR DIMENSIONS [INCHES / MM]	MAX LOAD [LBS / KG]	WEIGHT [LBS / KG]	FITS DEVICE	TABLET POCKET	LITERSIZE [L]
ALTA SKY 68	134×71×22.9 / 340×180×580	141×9×234 / 360×230×595	35.3 / 16.0	6.5 / 2.9	11" TABLET / 16" LAPTOP	YES	36
ALTA SKY 66	10.2×94×24 / 260×240×610	11.3×11.3×24.3 / 290×290×620	23.1 / 10.5	5.5 / 2.5	11" TABLET	YES	30
ALTA SKY 62	114×6.5×50.1 / 290×165×510	14.1×11.3×21.5 / 360×285×545	30.86 / 14.0	5.86 / 2.66	11" TABLET / 16" LAPTOP	YES	244
ALTA SKY 42	9.5×5.9×18.5 / 240×150×470	10.6×10.4×19.9 / 270×265×505	26.46 / 12.0	4.14 / 1.88	12.9" TABLET	YES	16.9
ALTA SKY 53	12.6×7.8×20.8 / 320×200×530	15×10.6×22.8 / 380×270×580	35.2 / 16.0	6.2 / 2.8	17" LAPTOP	YES	34
ALTA SKY 51D	12.6×7.8×20 / 320×200×510	14.6×10.2×22.2 / 370×260×565	29.7 / 13.5	6.5 / 2.9	15" LAPTOP	YES	32
ALTA SKY 45D	10.2×7.5×17.7 / 260×190×450	12.2×9×19.5 / 310×230×495	19.8 / 9.0	4.8 / 2.2	13" LAPTOP	YES	22
VEO ACTIVE BIRDER 56	12.2×71×22.04 / 310×180×560	12.9×9.8×22.8 / 330×250×580	48.5 / 22	5.3 / 2.4	10" TABLET / 16" LAPTOP	YES	47
VEO ACTIVE 53	12.2×71×20.9 / 310×180×530	12.9×9.8×21.7 / 330×250×550	44.1 / 20	6.4 / 2.9	10" TABLET / 16" LAPTOP	YES	45
VEO ACTIVE 49	12.2×71×19.3 / 310×180×490	12.9×9.8×20.1 / 330×250×510	35.3 / 16	6 / 2.7	10" TABLET / 15" LAPTOP	YES	35
VEO ACTIVE 46	10.6×6.3×18.1 / 270×160×460	11.4×9.1×18.7 / 290×230×475	24.2 / 11	5.6 / 2.5	10" TABLET / 14" LAPTOP	YES	25
VEO ACTIVE 42M	9.8×5.9×17.7 / 250×150×420	10.6×7.5×17.3 / 270×190×440	18.7 / 8.5	4.3 / 1.96	10" TABLET / 13" LAPTOP	YES	17
VEO SELECT 59T	13×6.8×18.5 / 330×170×470	14.2×8.7×21.5 / 360×220×545	33.1 / 15	9.22 / 4.18	11" TABLET / 17" LAPTOP	/	26
VEO SELECT 58T	11.8×6.9×18.5 / 300×175×470	14.2×10.2×24 / 360×260×610	33.1 / 15	11.24 / 5.10	11" TABLET / 16" LAPTOP	/	26
VEO SELECT 55BT	12.3×6.3×17.5 / 310×160×445	14.2×8.2×22.1 / 360×220×560	27.6 / 12.5	9.52 / 4.32	11" TABLET / 15" LAPTOP	/	22
VEO SELECT 42T	14.6×6.3×13 / 370×160×330	16.5×9.9×17.9 / 420×250×455	26.5 / 12	8.55 / 3.88	11" TABLET / 15" LAPTOP	/	20
VEO SELECT 48BF	11.8×6.5×18.9 / 300×165×480	13.3×9.6×20.5 / 335×245×520	25.5 / 11.6	4.2 / 1.9	11" TABLET / 15" LAPTOP	/	24
VEO SELECT 45BFM	10.6×5.1×16.9 / 270×130×430	11.8×8.3×18.3 / 300×210×465	19.1 / 8.7	3.2 / 1.4	11" TABLET	/	15
VEO SELECT 46BR	9.9×5.9×18.1 / 250×150×460	11.0×8.3×18.7 / 280×210×475	19.8 / 9.0	3.0 / 1.3	13" LAPTOP	/	17
VEO SELECT 37BRM	10.0×4.5×14.6 / 255×115×370	11.0×6.9×15.4 / 280×175×390	9.3 / 4.2	2.3 / 1.0	11" TABLET	/	11
VEO SELECT 49	11.3×4.9×19.2 / 290×125×490	13.3×8.1×19.9 / 340×205×505	20.2 / 9.2	3.6 / 1.6	15" LAPTOP	/	18
VEO SELECT 45M	10.9×4.4×17.7 / 275×110×450	12.6×7.5×18.1 / 320×190×460	17.1 / 7.8	3.3 / 1.5	15" LAPTOP	/	14
VEO SELECT 43RB	9×4.9×16.5 / 230×125×420	12.3×8.1×18.5 / 310×205×470	16.5 / 7.5	2.7 / 1.2	11" TABLET	/	12
VEO SELECT 39RBM	8.3×4×15 / 210×100×380	10.7×6.8×16.9 / 270×170×430	9.3 / 4.2	2.3 / 1.0	11" TABLET	/	8
VEO SELECT 36S	14.6×6.9×9.0 / 370×175×230	15.8×9.9×11.4 / 400×250×290	24.2 / 11	3.7 / 1.6	13" LAPTOP	/	15
VEO SELECT 28S	11.0×6.5×9.0 / 280×165×230	12.8×9.0×11.0 / 325×230×280	15.4 / 7	3.0 / 1.3	11" TABLET	/	10
VEO SELECT 22S	9.3×4.8×7.3 / 235×120×185	10.6×6.8×9.0 / 270×170×230	6.6 / 3	1.6 / 0.7	7.9" TABLET	/	5
VEO CITY B46	114×6.1×18.1 / 290×155×460	12.6×9.1×18.5 / 320×230×470	28.7 / 13	5.2 / 2.4	10.9" TABLET / 15" LAPTOP	/	23
VEO CITY B42	10.3×5.7×16.5 / 260×145×420	12×8.9×16.9 / 305×225×430	22.1 / 10	4.4 / 2.0	8.3" TABLET / 13" LAPTOP	/	18
VEO CITY B37	8.6×5.5×15 / 220×140×380	10.3×8.9×15.8 / 260×225×400	15.4 / 7	3.5 / 1.6	10.9" TABLET	/	13
VEO CITY S36	14.1×4.8×9.5 / 360×120×240	15×8.3×10 / 380×210×255	19.8 / 9	3.5 / 1.6	13" LAPTOP	/	11
VEO CITY S30	11.8×4.4×8.3 / 300×110×210	13.3×8.1×8.6 / 335×205×220	13.2 / 6	2.9 / 1.3	10.9" TABLET	/	8
VEO CITY CB 34	11.4-13×3.9×9.3 / 290-330×100×235	13.8×5.8×9.9 / 350×145×250	18.7 / 8.5	2.25 / 1.02	12.9" TABLET	/	8
VEO CITY CB 29	10.3-11.4×3.5×7.9 / 260-290×90×200	12.3×5.4×8.5 / 310×135×215	11.0 / 5	1.81 / 0.82	8.3" TABLET	/	6
VEO CITY CB 24	8.6-9.5×3.1×5.8 / 220-240×80×140	10.3×4.8×6.3 / 260×120×160	5.5 / 2.5	1.28 / 0.58	/	/	3
VEO CITY TP 33	13.4×3.8×9.9 / 340×95×250	14.1×6.5×10.6 / 360×165×270	17.6 / 8	2.60 / 1.18	12.9" TABLET / 13" LAPTOP	/	8
VEO CITY TP 28	11×3.4×6.8 / 280×85×170	11.8×4.8×7.6 / 300×120×195	6.6 / 3	1.54 / 0.70	8.3" TABLET	/	4
VEO CITY TP 23	9×3.4×5.5 / 230×85×140	9.9×4.8×6.3 / 250×120×160	4.4 / 2	1.23 / 0.56	/	/	2.5
VEO ADAPTOR R48	10.3×6.3×18.0 / 260×160×480	11.4×8.6×19.3 / 290×220×490	25.4 / 11.5	3.22 / 1.46	16" MACBOOK	/	20
VEO ADAPTOR R44	8.6×6.3×16.9 / 220×160×430	10.3×8.6×17.8 / 260×220×450	19.8 / 9.0	2.78 / 1.26	13" MACBOOK	/	16

## BAGS SPEC SHEET

MODEL	INTERIOR DIMENSIONS [INCHES / MM]	EXTERIOR DIMENSIONS [INCHES / MM]	MAX LOAD [LBS / KG]	WEIGHT [LBS / KG]	FITS DEVICE	TABLET POCKET	LITERSIZE [L]
VEO ADAPTOR 24M	8.9×4.5×6.3 / 225×115×160	9.8×5.9×9.1 / 250×150×230	254 / 11.5	0.97 / 0.44	8" TABLET	/	4.1
VEO ADAPTOR 15M	7.1×4.1×5.9 / 180×105×150	8.3×5.3×8.7 / 210×135×220	19.8 / 9.0	0.71 / 0.32	/	/	2.8
VEO GO 46M	10.4×4.1×18.1 / 265×105×460	11.4×5.5×18.5 / 290×140×470	15.9 / 7.2	2.20 / 1.00	13" LAPTOP	/	13
VEO GO 42M	9.6×3.8×16.5 / 245×95×420	10.3×5.1×16.9 / 260×130×430	8.8 / 4.0	1.98 / 0.90	11" TABLET	/	9.8
VEO GO 24M	8.8×4.1×6.2 / 225×105×160	9.5×4.8×7.1 / 240×125×180	6.6 / 3.0	0.75 / 0.34	/	/	3.8
VEO GO 21M	8.3×4.1×7.5 / 210×105×190	10.6×5.8×8.3 / 270×145×210	6.2 / 2.8	0.93 / 0.42	7.9" TABLE	/	4.2
VEO GO 15M	7.1×4.1×6.2 / 180×105×160	7.6×4.8×7.1 / 195×125×180	3.3 / 1.5	0.68 / 0.31	/	/	3.0
VEO RANGE 38	15.1×5.7×11.7 / 385×145×300	16.8×8.2×13.3 / 430×210×340	15.9 / 7.2	2.64 / 1.20	15" LAPTOP	/	17
VEO RANGE 32M	12.6×5.3×9.1 / 320×135×230	14.2×6.5×9.8 / 360×165×250	12.1 / 5.5	1.85 / 0.84	12.9" TABLET	/	10
VEO RANGE 21M	9.2×4.4×7.5 / 235×110×190	10.6×6.3×8.6 / 270×160×220	6.2 / 2.8	1.06 / 0.48	7.9" TABLET	/	5
VESTA ASPIRE 4I	8.9×5.9×16.1 / 225×150×410	10×8.7×18.3 / 255×220×465	11.0 / 5	1.70 / 0.77	9.7" TABLET	/	14
VESTA ASPIRE 33	13×5.4×9.3 / 330×135×235	15×7.5×10.4 / 380×190×265	14.3 / 6.5	1.7 / 0.76	12.9" TABLET	/	10.5
VESTA ASPIRE 30	11.8×6.8×8.3 / 300×170×210	14.1×8.5×9.9 / 360×215×250	13.2 / 6	1.5 / 0.68	11" TABLET	/	10.7
VESTA ASPIRE 25	10.2×6.7×8.3 / 260×170×210	11.4×8.1×10 / 290×205×255	9.9 / 4.5	1.06 / 0.48	9" TABLET	/	9.3
VESTA ASPIRE 21	8.7×5.3×7.7 / 220×135×195	9.8×6.5×8.7 / 250×165×220	5.1 / 2.3	0.73 / 0.33	/	/	5.8
VESTA ASPIRE 16Z	6.1×4.9×10.9 / 155×125×275	7.9×6.8×13 / 200×170×330	4.4 / 2.5	0.71 / 0.32	/	/	5.3
VESTA ASPIRE 15	6.3×4.5×5.9 / 160×115×150	7.0×5.9×7.9 / 180×150×200	3.3 / 1.5	0.48 / 0.22	/	/	2.8
VESTA ASPIRE 15Z	5.9×4.9×7.9 / 150×125×200	6.9×5.7×9.4 / 175×145×240	4.9 / 2.2	0.51 / 0.23	/	/	3.8
VESTA ASPIRE 12	6.3×3.8×4.4 / 160×95×110	8.1×4.8×6.1 / 205×120×155	2.2 / 1.0	0.4 / 0.18	/	/	1.6
VEO BIB F36	11.0×6.3×15.0 / 280×160×380	12.6×7.7×16.1 / 320×195×410	16.5 / 7.5	2.29 / 1.0	11" TABLET	/	17
VEO BIB F33	11.0×6.3×11.0 / 280×160×280	12.4×7.7×12.4 / 315×195×315	13.2 / 6	1.90 / 0.86	11" TABLET	/	13
VEO BIB F28	11.0×6.3×7.1 / 280×160×180	12.4×7.7×9.3 / 315×195×235	9.9 / 4.5	1.50 / 0.68	7" TABLET	/	8
VEO BIB F27	8.3×4.3×11.0 / 210×110×280	9.4×5.7×12.4 / 240×145×315	8.4 / 3.8	1.19 / 0.54	7" TABLET	/	6.5
VEO BIB T25	9.8×4.3×7.5 / 250×110×190	10.8×5.5×8.3 / 275×140×210	7.1 / 3.2	1.15 / 0.52	/	/	5.2
VEO BIB T22	8.7×3.9×6.3 / 220×100×160	9.8×5.1×7.3 / 250×130×185	6.2 / 2.8	0.88 / 0.40	/	/	3.5
VEO BIB T18	7.1×3.9×5.5 / 180×100×140	8.3×5.1×6.7 / 210×130×170	4.4 / 2.0	0.71 / 0.32	/	/	2.5
VEO BIB DIVIDER S53	21.1×6.9×15.7 / 535×175×400	22.0×8.7×17.1 / 560×220×435	29.8 / 13.5	6.70 / 3.04	15" LAPTOP	/	38
VEO BIB DIVIDER S46	17.5×6.9×12.8 / 445×175×325	18.9×8.5×14.0 / 480×215×355	24.2 / 11.0	5.33 / 2.42	13" LAPTOP	/	26
VEO BIB DIVIDER S40	15.6×5.9×9.6 / 395×150×245	17.1×7.5×10.8 / 435×190×275	19.2 / 8.7	3.92 / 1.78	11" TABLET	/	15
VEO BIB DIVIDER S37	13.6×5.9×8.1 / 345×150×205	15.4×7.5×9.8 / 390×190×250	13.7 / 6.2	3.13 / 1.42	7" TABLET	/	11
DIVIDER BAG 53	21×15.8×6.9 / 535×400×175	22×16.8×7.9 / 560×425×200	/	3.64 / 1.65	/	/	38
DIVIDER BAG 46	17.5×12.9×6.9 / 445×325×175	18.8×13.7×7.6 / 480×345×195	/	3.00 / 1.34	/	/	26
DIVIDER BAG 40	15.5×9.6×5.9 / 395×245×150	17×10.9×6.8 / 430×275×170	/	1.98 / 0.90	/	/	15
DIVIDER BAG 37	13.7×8.1×5.9 / 345×205×150	15×9.8×6.8 / 380×240×170	/	1.65 / 0.75	/	/	11
SUPREME 53F/53D	22×17.7×7.8 / 560×450×200	24.8×20.4×9.4 / 630×520×240	/	23 / 10.4	/	/	/
SUPREME 46F/46D	18.9×14.5×7.8 / 480×370×200	20.2×17.1×8.6 / 515×435×220	/	15 / 6.8	/	/	/
SUPREME 40F/40D	16.9×11.6×6.8 / 430×295×175	18.3×14.3×7.6 / 465×365×195	/	9.7 / 4.4	/	/	/
SUPREME 37F/37D	16.3×10.2×6.8 / 380×260×175	16.3×9.2×7.6 / 415×325×195	/	8.6 / 3.9	/	/	/
SUPREME 27F/27D	11×9.8×6.6 / 250×190×150	11×9.8×6.6 / 280×250×170	/	4.19 / 1.9	/	/	/

## BAGS ACCESSORIE SSPEC SHEET

MODEL	INTERIOR DIMENSIONS [ INCHES / MM ]	EXTERIOR DIMENSIONS [ INCHES / MM ]	MAX LOAD [ LBS / KG ]	WEIGHT [ LBS / KG ]
ALTA ACTION 80	31.5×6.7×5.1 / 800×170×130	32.1×7.1×5.5 / 815×180×140	8.8 / 4.0	0.84 / 0.38
ALTA ACTION 70	27.5×6.7×5.1 / 700×170×130	28.1×7.1×5.5 / 715×180×140	7.7 / 3.5	0.77 / 0.35
ALTA ACTION 60	23.6×5.5×3.8 / 600×140×100	24.2×5.8×4.3 / 615×150×110	6.6 / 3	0.66 / 0.30

## OPTICS SPEC SHEET

MODEL	POWER [ X ]	OBJECTIVE LENS [ MM ]	FIELD OF VIEW [ FT/1000 YDS   M/1000 M ]	NEAR FOCUS [ FEET   M ]	EYE RELIEF [ MM ]	WEIGHT [ LBS   G ]
VEO HD IV 82A	20-60	82	1044~57   34.8~18.7	19.7~21.3   6~6.5	18~22	4.32   1960
VEO HD IV 65A	18.75-45	65	125.7~68   41.9~22.7	19.7~21.3   6~6.5	18~21	3.43   1560
VEO HD 80A	20~60	80	110~52   37~17	19.7~21.3   6~6.5	19~20	3.41   1550
VEO HD 60A	15~45	60	141~68   47~23	19.7~21.3   6~6.5	19~20	2.65   1205
VESTA 560A	15-45	60	1044~62.6   34.8~20.9	26.3~29.5   8~9	16~21	2.85   1293
VESTA 460A	15-50	60	125.3~57.4   41.7~19.1	32.8~39.4   10~12	11	1.34   609
VESTA 350A	15~45	50	156.6~52.2   52.2~17.4	29.5~39.4   9~12	11	1.32   600

MODEL	POWER [ X ]	OBJECTIVE LENS [ MM ]	FIELD OF VIEW [ FT/1000 YDS   M/1000 M ]	NEAR FOCUS [ FEET   M ]	EYE RELIEF [ MM ]	ADJUST. PUPILLARY [ MM ]	WEIGHT [ LBS   G ]
VEO HD IV 1042	10	42	340   114	5.9   1.8	19	56~74	1.71   776
VEO HD IV 8420	8	42	377   126	5.9   1.8	19	56~74	1.70   775
VEO HD 2 1042	10	42	340   114	6.5   2	18	58~74	1.58   720
VEO HD 2 8420	8	42	374   124	6.5   2	19	58~74	1.58   720
VEO HD 1042	10	42	342   114	6.6   2	18	58~74	1.69   767
VEO HD 8420	8	42	372   124	6.6   2	19	58~74	1.67   760
VEO ED 1250	12	50	251   84	11.5   3.5	18	60~75	1.67   760
VEO ED 1250	10	50	282   94	9.8   3	19	59.5~75	1.72   782
VEO ED 1042	10	42	314   105	9.2   2.8	16	55~75	1.41   640
VEO ED 8420	8	42	330   110	8.2   2.5	19	55~75	1.41   640
VEO XF 1042	10	42	332   111	6.9   2.1	16	57~74	1.41   640
VEO XF 8420	8	42	418   133	6.9   2.1	20	57~74	1.45   660
VESTA 1042	10	42	298   100	6.9   2.1	17	56~74	1.30   590
VESTA 8420	8	42	325   108	6.9   2.1	19	56~74	1.34   610
VESTA 1025	10	25	330   110	8.2   2.5	10	56~74	0.61   280
VESTA 8250	8	25	340   114	8.2   2.5	12.5	56~74	0.61   280
VESTA 1021	10	42	100.9   302.7	4   13.2	8	56.5~72	0.42   195
VESTA 8210	8	42	123.5   370.6	4   13.2	10	56.5~72	0.42   195

MODEL	POWER [ X ]	OBJECTIVE LENS [ MM ]	FIELD OF VIEW [ FT/1000 YDS   M/1000 M ]	NEAR FOCUS [ FEET   M ]	EYE RELIEF [ MM ]	WEIGHT [ LBS   G ]
VEO HD 2 1042M	10	42	342   114	6.5   2.1	18	0.71   325
VEO ED 8420M	10	42	324   108	8.2   2.5	19	0.66   300
VESTA 8320M	10	32	392   131	6.5   2	17.7	0.55   250



**VANGUARD**

[WWW.VANGUARDWORLD.COM](http://WWW.VANGUARDWORLD.COM)